

Product Manual

Solista LX Ceiling VAD Range



Responsibility	Name	Job Title	Signature	Date
Facilitator	Philip Williams	Approvals Manager		7/6/13
Marketing	Steve Martin	Product Manager		07/06/13.
Technical	James Morgan	Design Manager		7/6/13

Cooper Fulleon Ltd
Llantarnam Park
Cwmbran
South Wales
NP44 3AW
+44 (0)1633 628500
www.fulleon.co.uk

Contents

<i>Title</i>	<i>Page</i>
INTRODUCTION	3
GENERAL FUNCTIONAL DESCRIPTION	3
Coverage Volume	4, 5
Current Consumption Data	6, 7
Installation Guidance & Advise	18
General Safety Advise	18
Maintaining IP ratings – Good Practice	18
Typical Wiring Configuration	19
Power Supplies & Control Panels	19
Wiring	20
Typical Wiring Calculations	20
Maintenance Advice	21
Annex A: Document Change Summary	22

Referenced Documents

<i>Title</i>	<i>Doc. Ref.</i>
Installation Guide (included with product)	25-11208

Introduction

The Solista LX Ceiling is a range of high specification VADs (Visual Alarm Devices) suitable for ceiling mounting in accordance with EN54-23. They are suitable for visual alarm signalling within enclosed areas, open areas or corridors and passages. The device has been specifically designed for use within fire alarm systems, to meet the requirements of the CPR (Construction Products Regulation). It produces a flash of light at a predetermined interval when connected to a suitable power supply. When connected to a common power supply, devices will self-synchronise their flashing for a defined period of time after starting (see installation guide for more detail).

Connection is via a screw terminal connector block for ease of termination of cables. Each connection has a terminal for looping in and out. The device is fixed to a suitable location using a choice of either a shallow, deep or 'U' bayonet mounting base.

General Functional Description

The device is normally in an off state, with no voltage applied to the power terminals. In this state, the device has no power and so does not operate.

When the device is required to operate, a voltage between 9 and 60V_{DC} is applied to the appropriate power terminals. This provides power to the circuit via a polarity protection / system monitoring diode, & an RC network which provides supply smoothing and noise immunity protection. Further protection is also provided against voltage spikes on the supply. At the heart of the device is a microprocessor which derives its power from a switched mode voltage regulator circuit. Clock timing and device synchronisation is provided via the oscillator clock drive crystal & associated capacitor network.

The light flash is achieved by the use of an LED (Light Emitting Diode). A drive circuit generates the necessary voltage & current required to drive the LED. Control of the flash is achieved via the microcontroller, which runs the programmed firmware for its operation.

Notes:

- See installation guide for details on technical specifications, connection instructions & mounting arrangements.

Coverage Ratings

VAD performance is now stated as an actual 'real world' coverage volume, rather than the old misleading & often inconsistent figures of point intensity (candela), circuit power (watts) or flash storage energy (joules).

As a result, achieving a more relevant & consistent performance is now more straight forward, since the actual coverage volume, area & distance of the VAD in an installation is stated.

Below are the coverage ratings for the Solista LX Ceiling range: -

Solista LX Ceiling (White Flash)

VAD Setting (High/Low)	Flash Rate Setting (Hz)	Cylindrical coverage diameter y (at mounting height x =3m) (m)	Floor Coverage Area (m ²)	Coverage Volume (m ³)	Current Consumption @ 24V _{DC} (mA)
High	1	7.5	44.17	132.5	25
Low	1	5	19.6	58.9	16
High	0.5	7.5	44.17	132.5	16
Low	0.5	5	19.6	58.9	10

Solista LX Wall (Chromaplus Flash)

Power Setting (High/Low)	Flash Rate Setting (Hz)	Width of Square Room y (at mounting height x =2.4m) (m)	Floor Coverage Area (m ²)	Coverage Volume (m ³)	Current Consumption @ 24V _{DC} (mA)
High	1	7.5	44.17	132.5	37
Low	1	5	19.6	58.9	21.1
High	0.5	7.5	44.17	132.5	23.2
Low	0.5	5	19.6	58.9	13.2

Solista LX Ceiling (Red Flash)

VAD Setting (High/Low)	Flash Rate Setting (Hz)	Cylindrical coverage diameter y (at mounting height x =3m) (m)	Floor Coverage Area (m ²)	Coverage Volume (m ³)	Current Consumption @ 24V _{DC} (mA)
High	1	7.5	44.17	132.5	25
Low	1	3	7	58.9	16
High	0.5	7.5	44.17	132.5	16
Low	0.5	3	7	58.9	10

The designators **x** & **y** are defined in EN54-23, and define the coverage volume of the VAD.

NOTE:

For more information, see the next page for an overview of the designators, or for more detailed information please refer to EN54-23 (EU) & COP 0001 (UK only).

Coverage Volume - Ceiling Mounted Devices

C-x-y

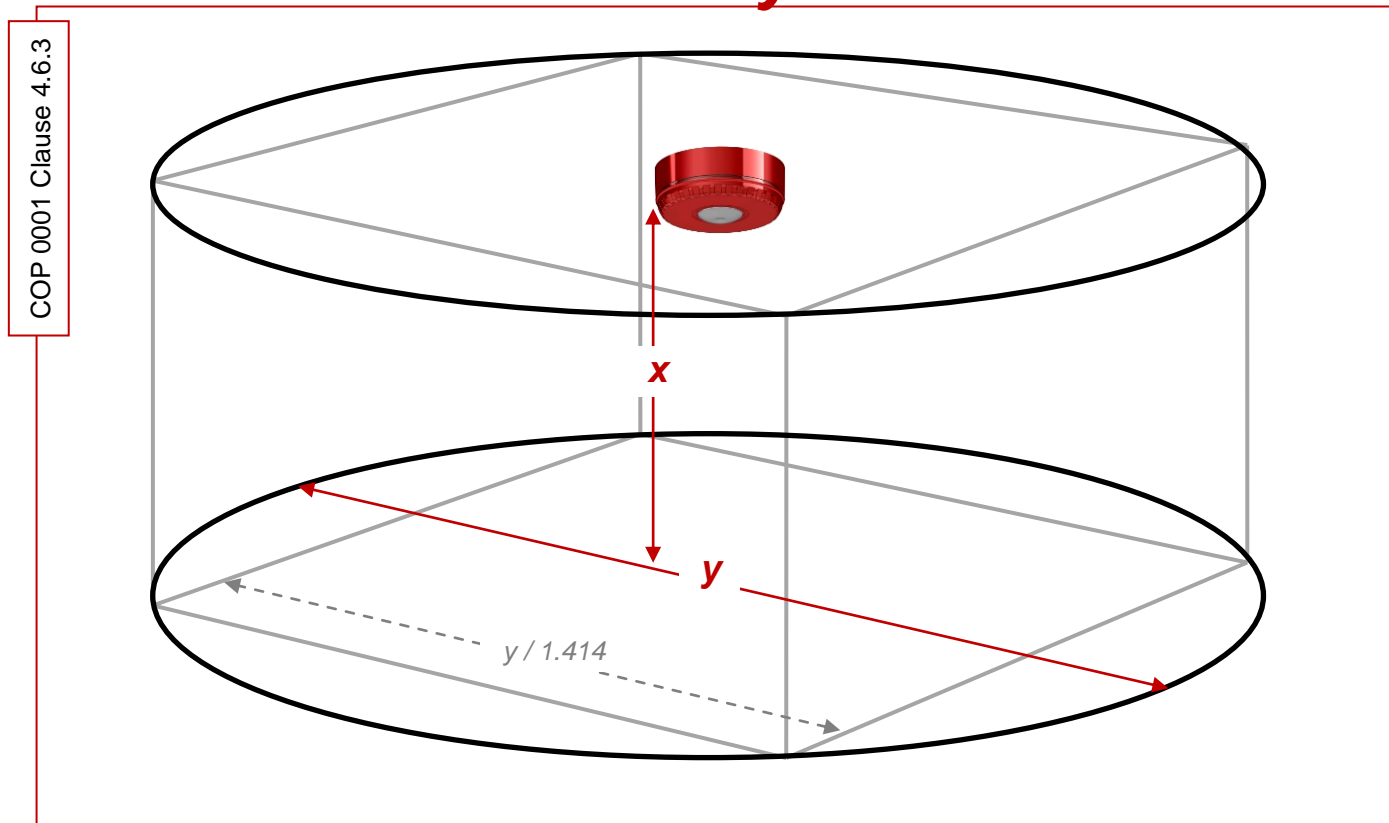

C – Ceiling Mounted Device

x – The maximum height of either 3, 6 or 9 meter at which the VAD may be mounted

y – The diameter in meters of the cylindrical volume covered (to a minimum level of 0.4lux) when the device is mounted to the ceiling at a height of 3, 6 or 9 meter

Example:

The diameter in meters of the cylindrical volume covered (to a minimum level of 0.4lux) when the device is mounted to the ceiling at a height of 3, 6 or 9 meter

✓ TOP TIP

- To convert the coverage diameter **y** to the width of a square room (or area)

$$\text{Width of square room} = y / 1.414 \text{ meter}$$

Current Consumption Data

VADS Solista start-up surge current @ 9V

1Hz/HP/Chromaplus

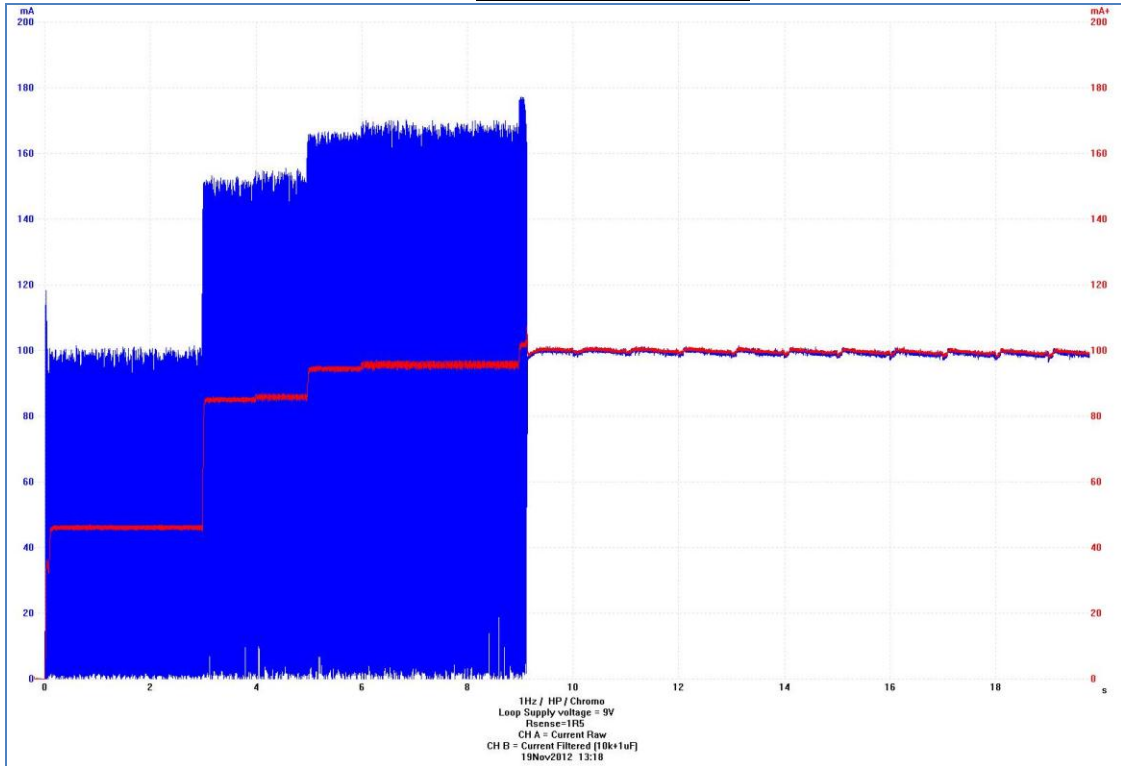

1Hz/HP/No Chromaplus

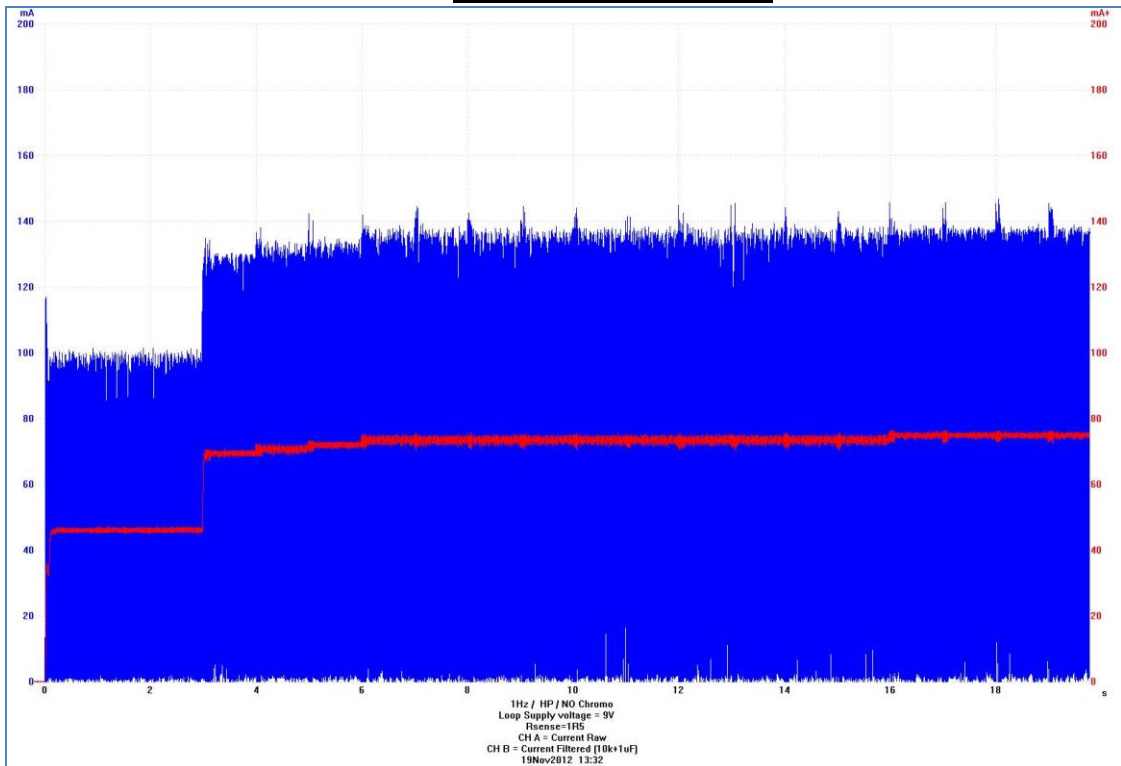

1Hz/LP/No Chromaplus

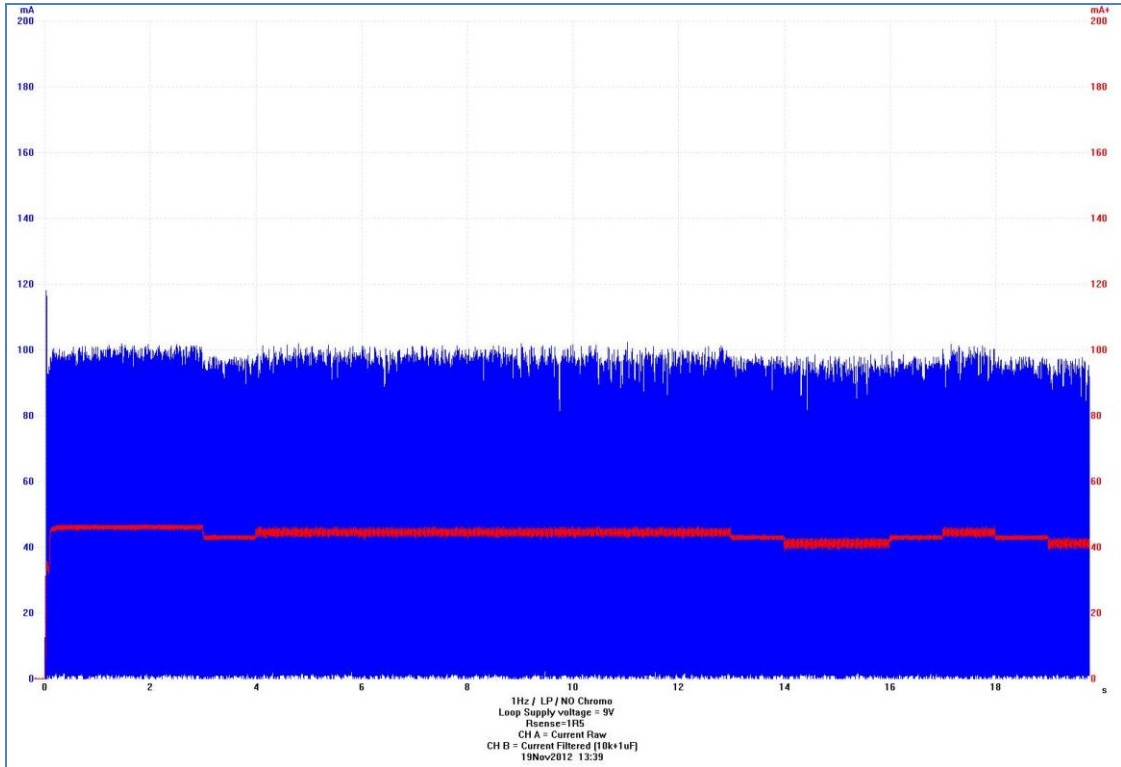

0.5Hz/HP/Chromaplus

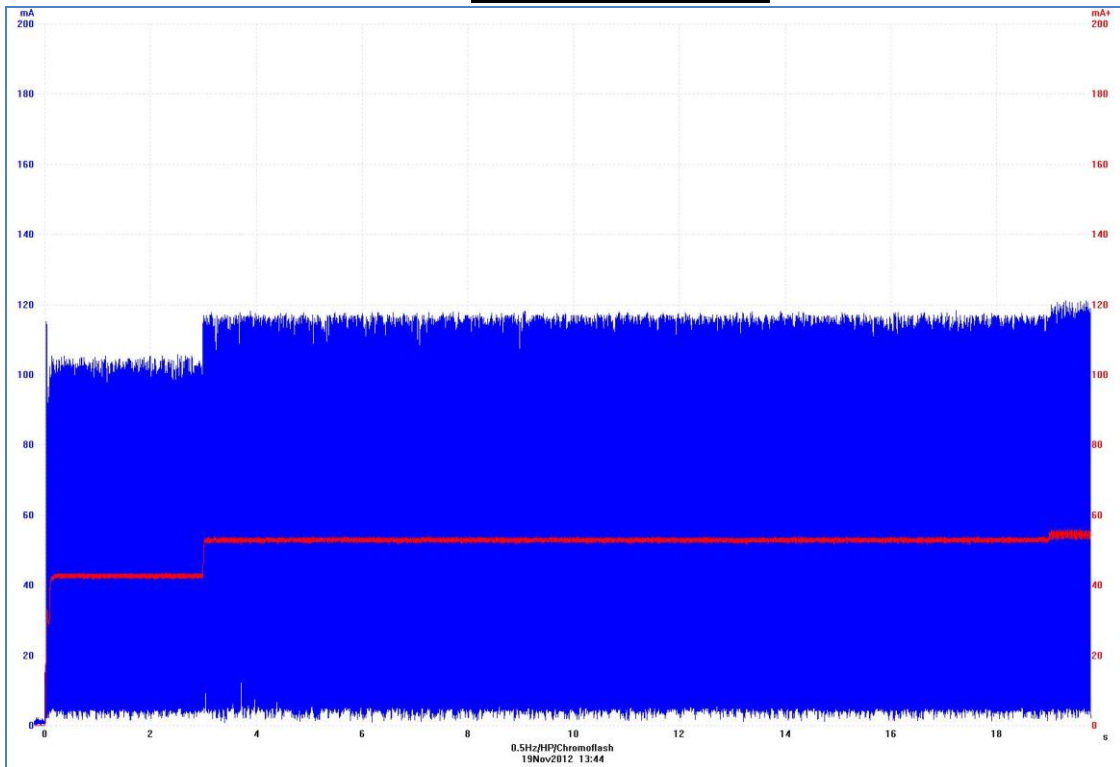

0.5Hz/HP/No Chromaplus

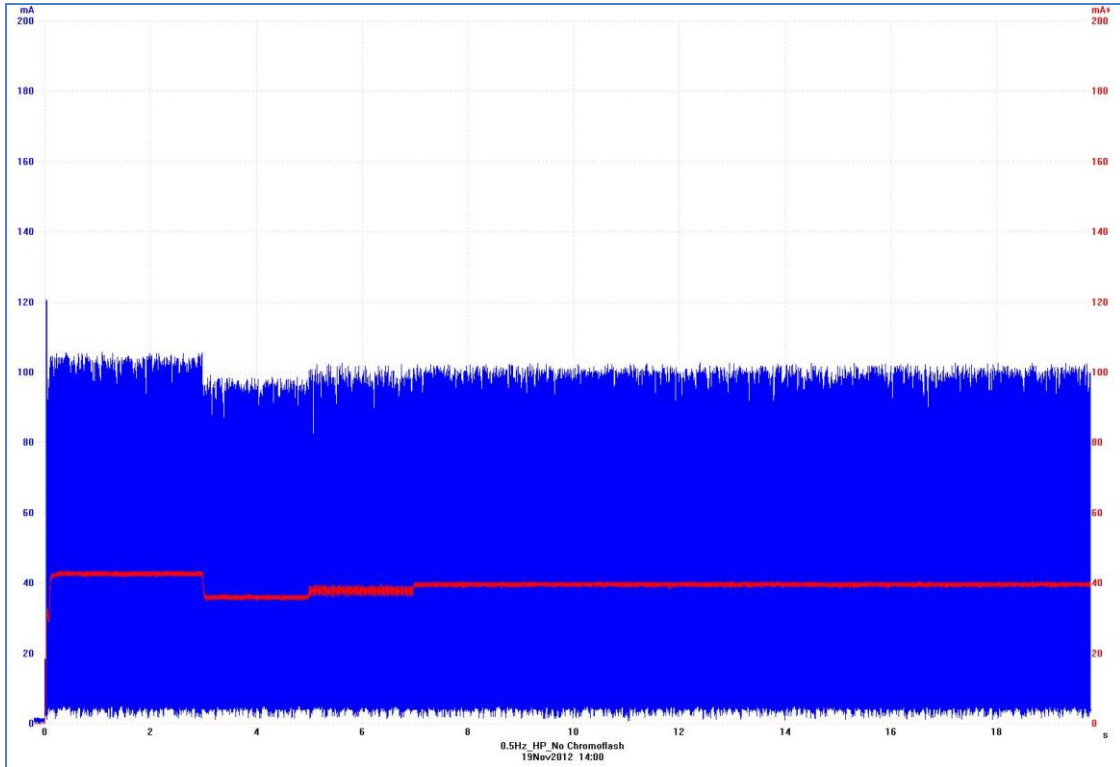

0.5Hz/LP/No Chromaplus

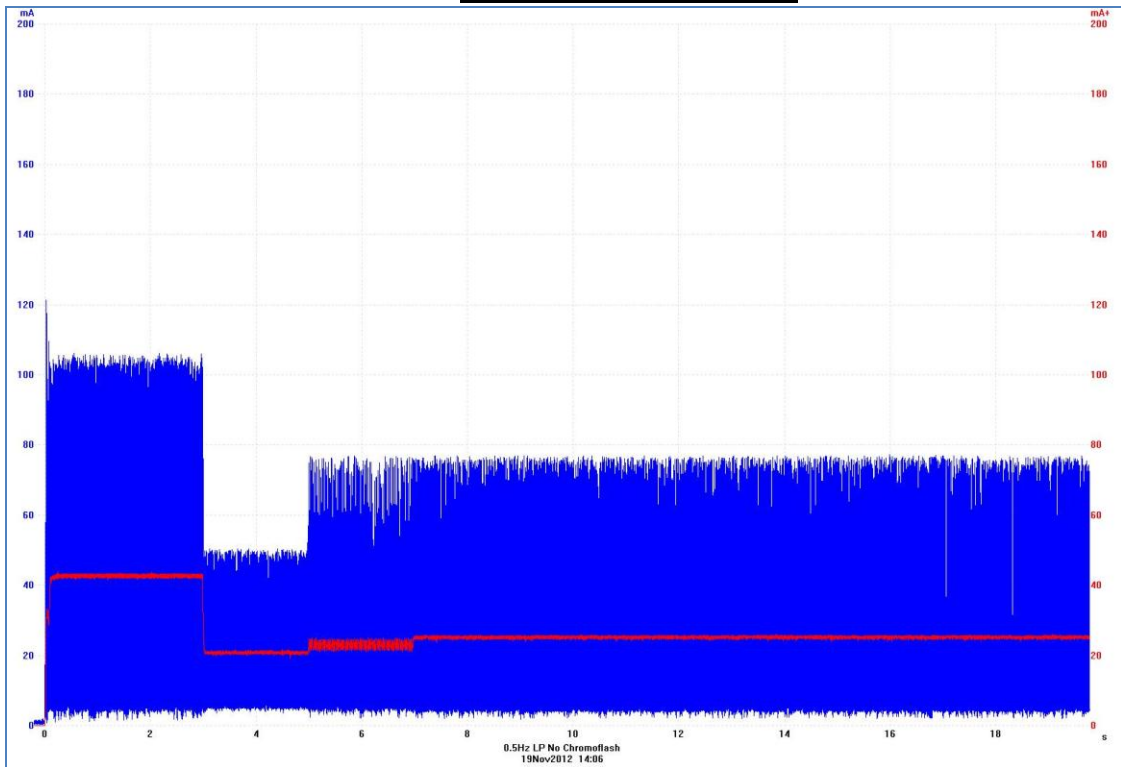

VADS Solista start-up surge current @ 24V

1Hz HP Chromaplus

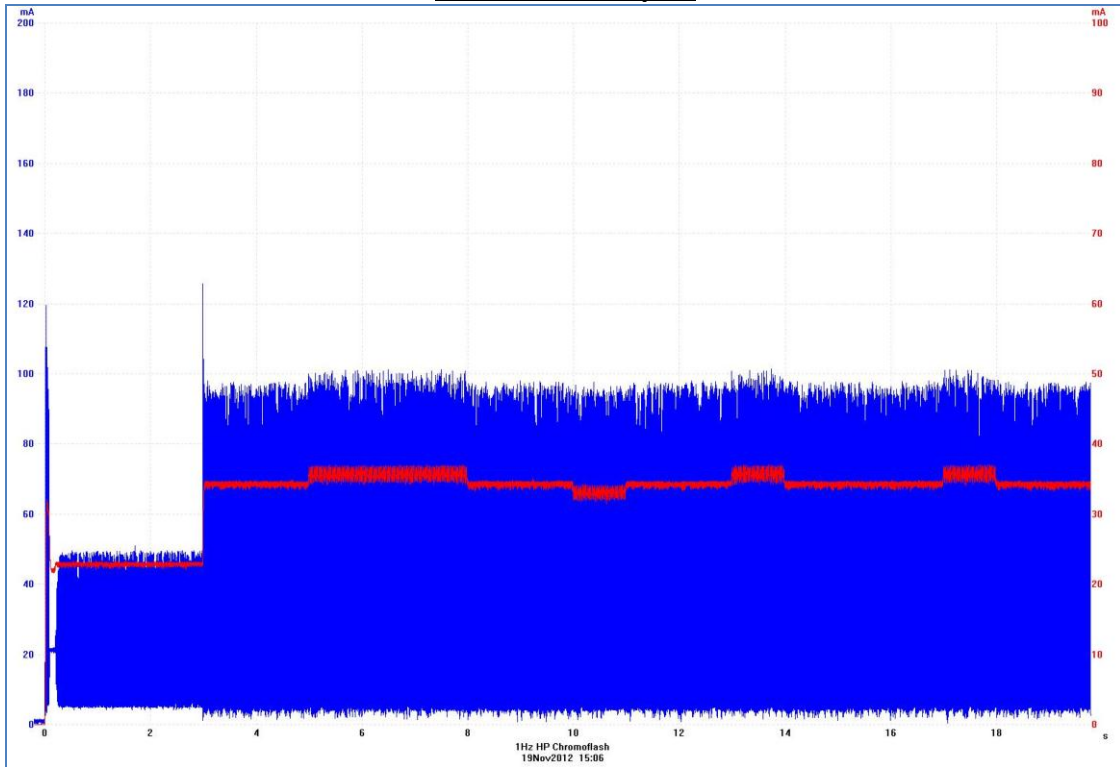

1Hz HP No Chromaplus

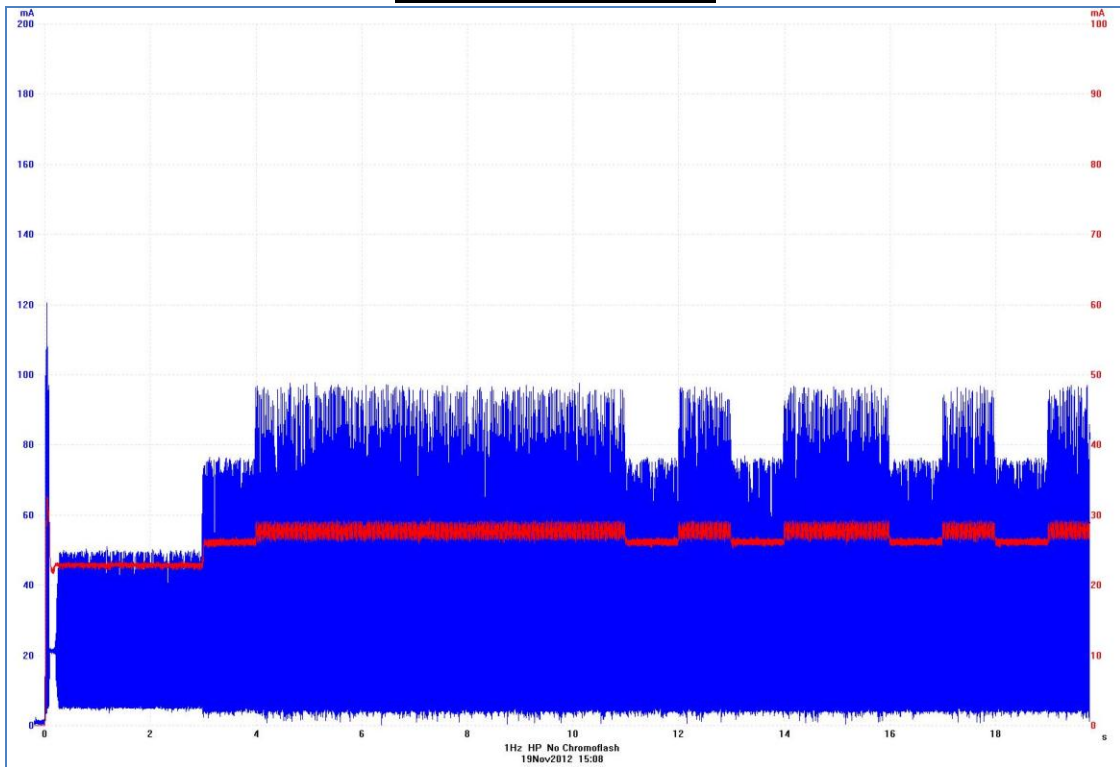

1Hz LP No Chromaplus

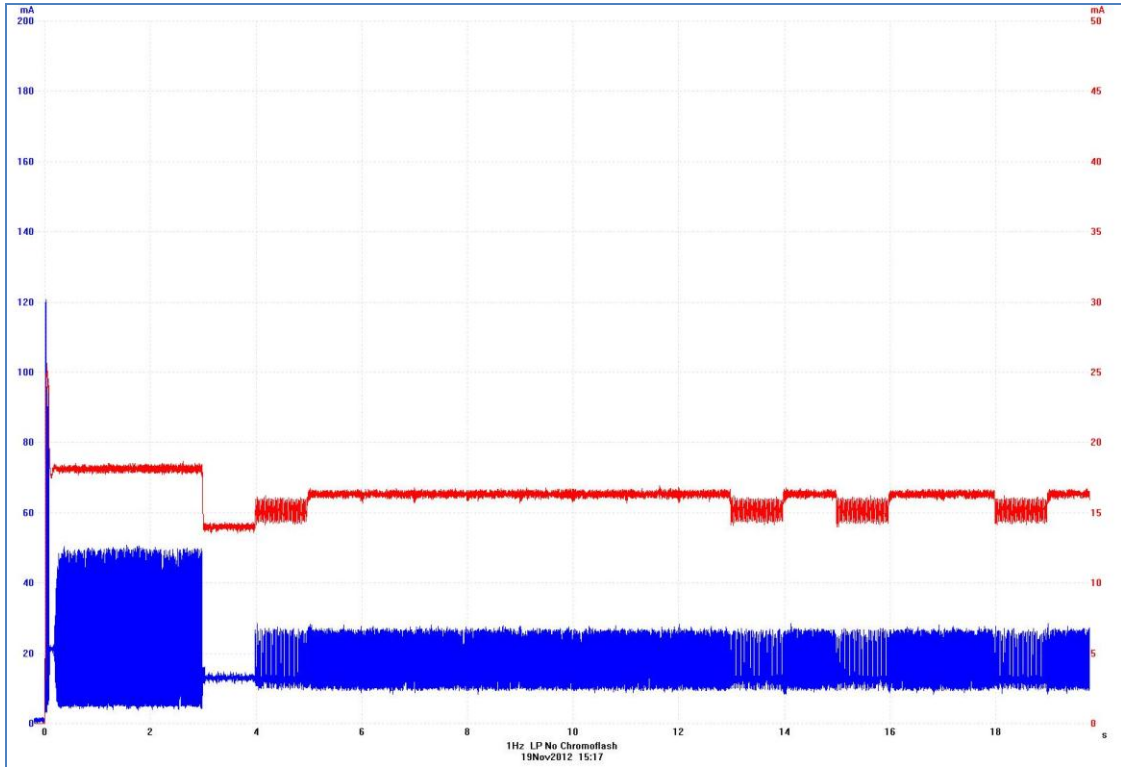

0.5Hz HP Chromaplus

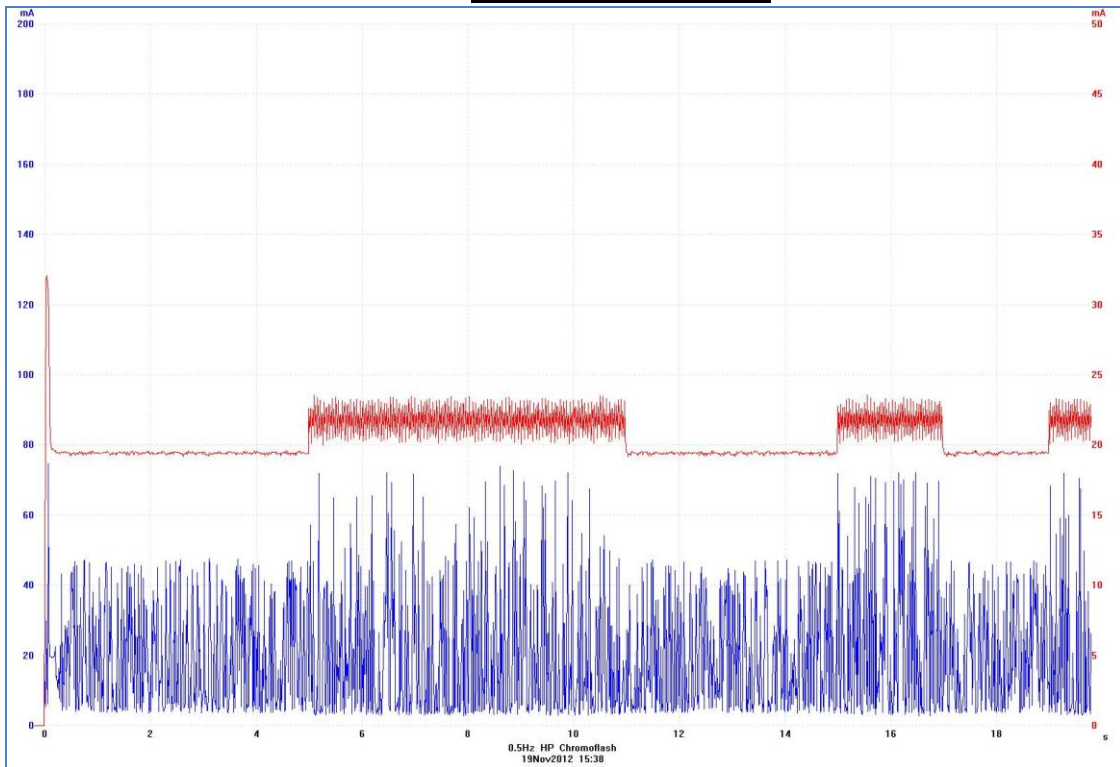

0.5Hz HP No Chromaplus

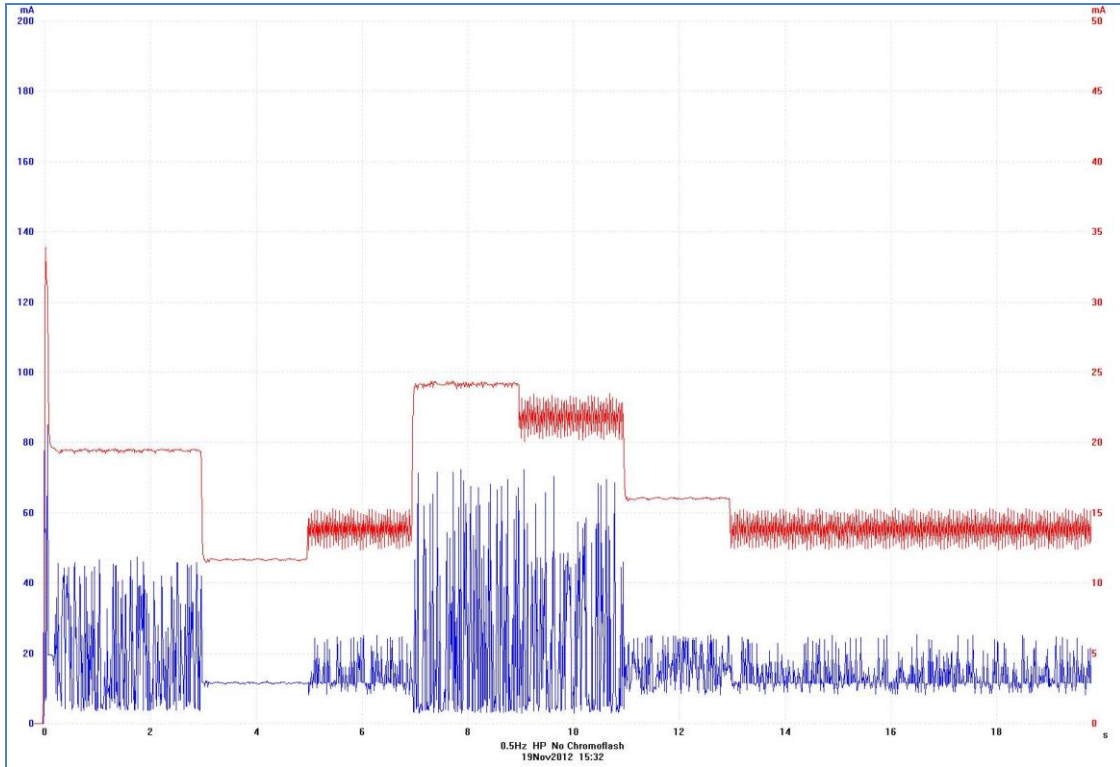

0.5Hz LP No Chromaplus

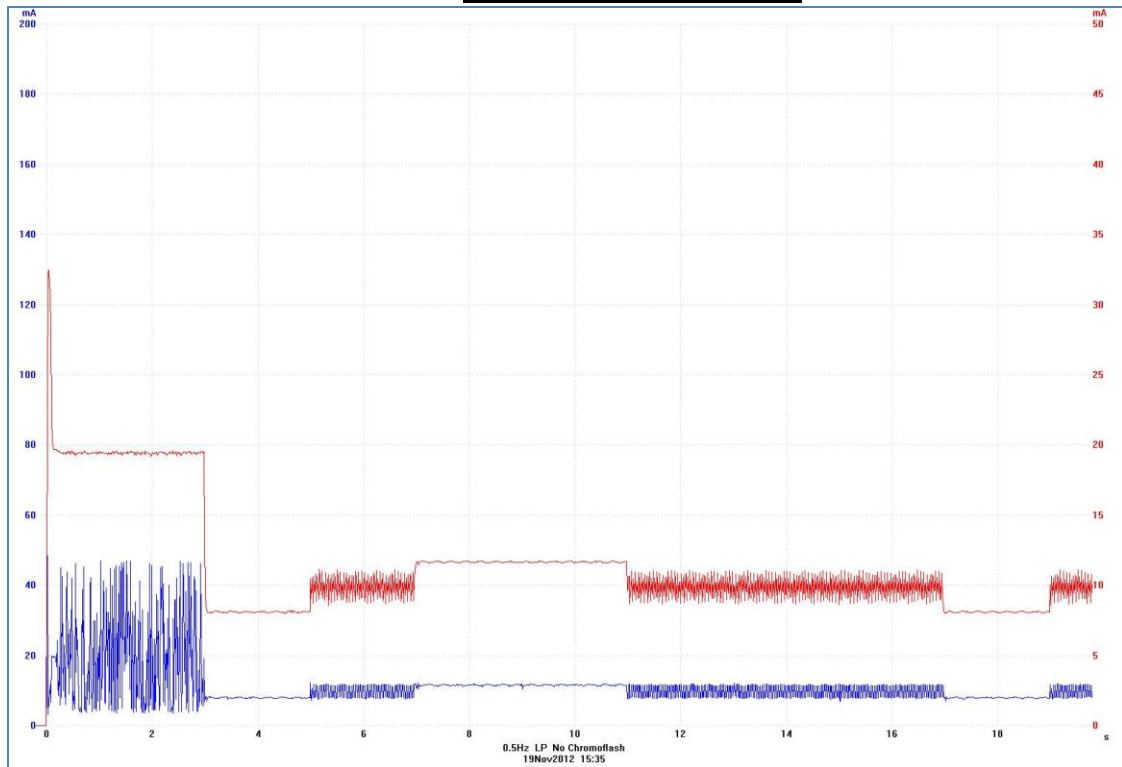

VADS Solista start-up surge current @ 60V

1Hz HP Chromaplus

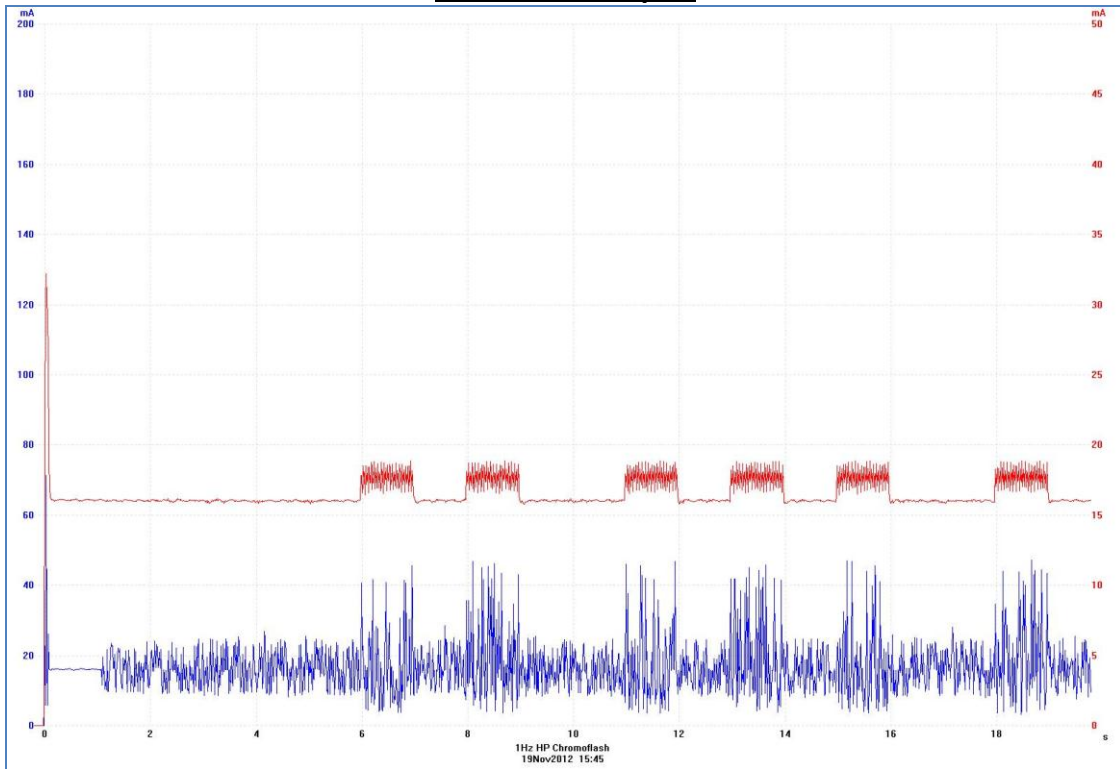

1Hz HP No Chromaplus

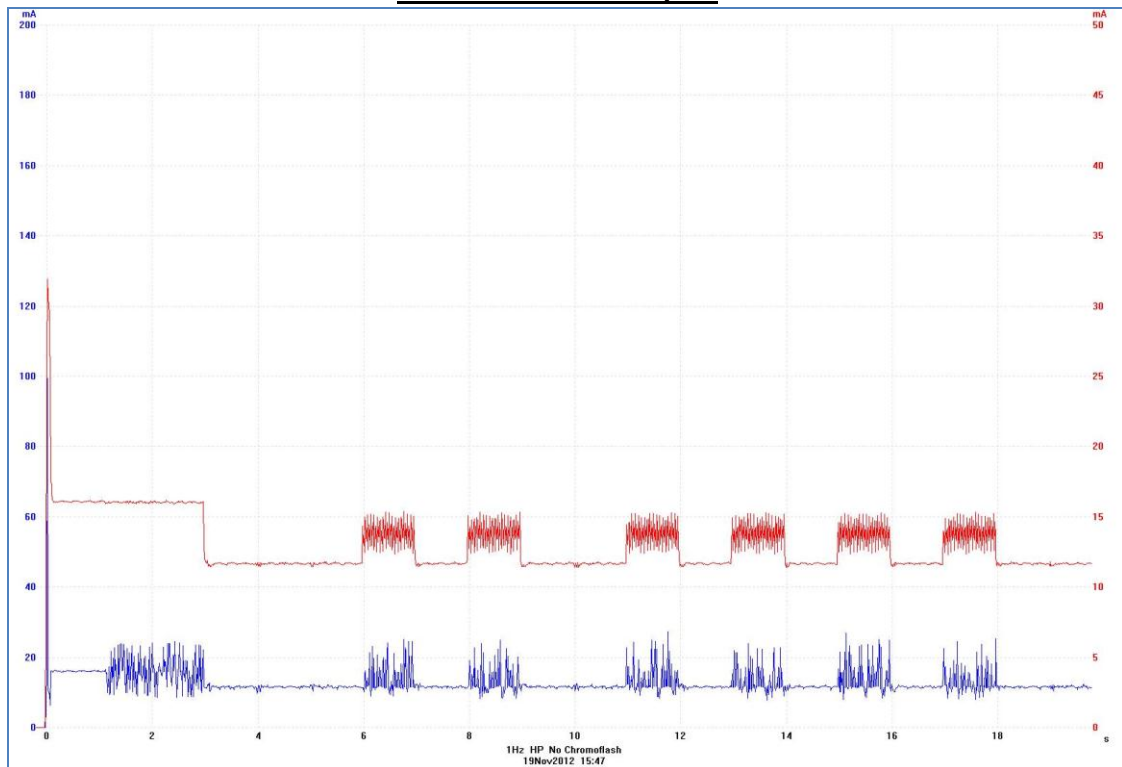

1Hz LP No Chromaplus

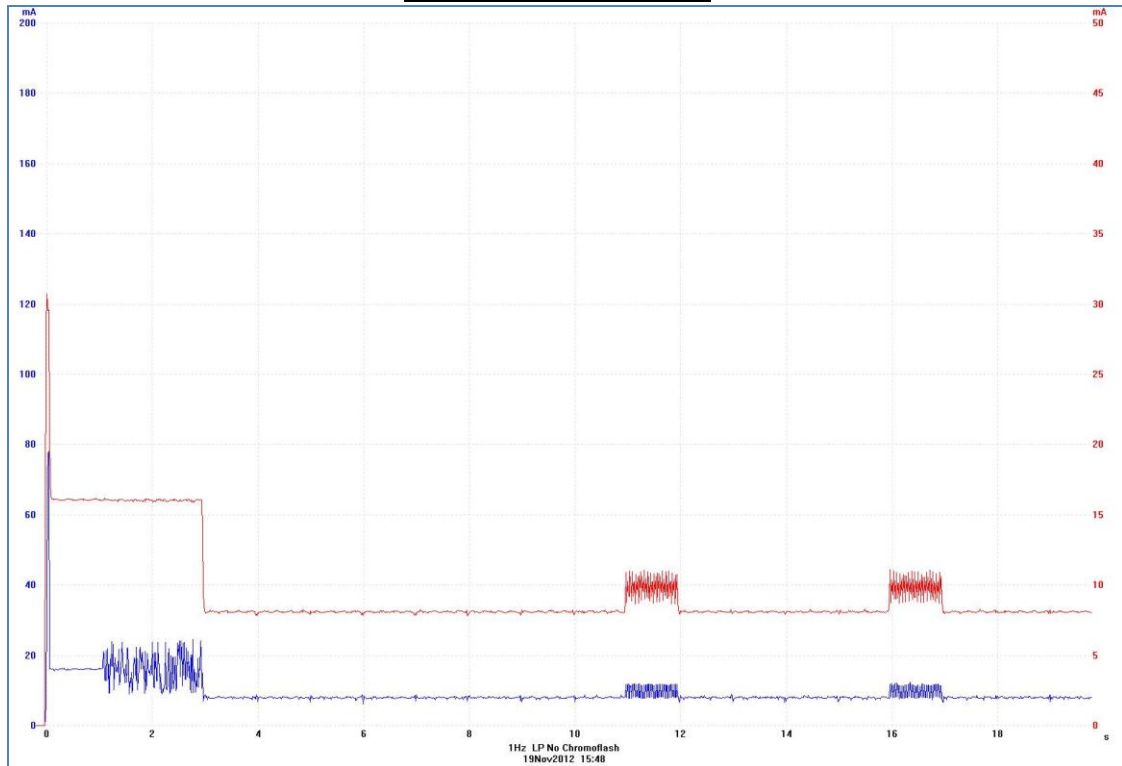

0.5Hz HP Chromaplus

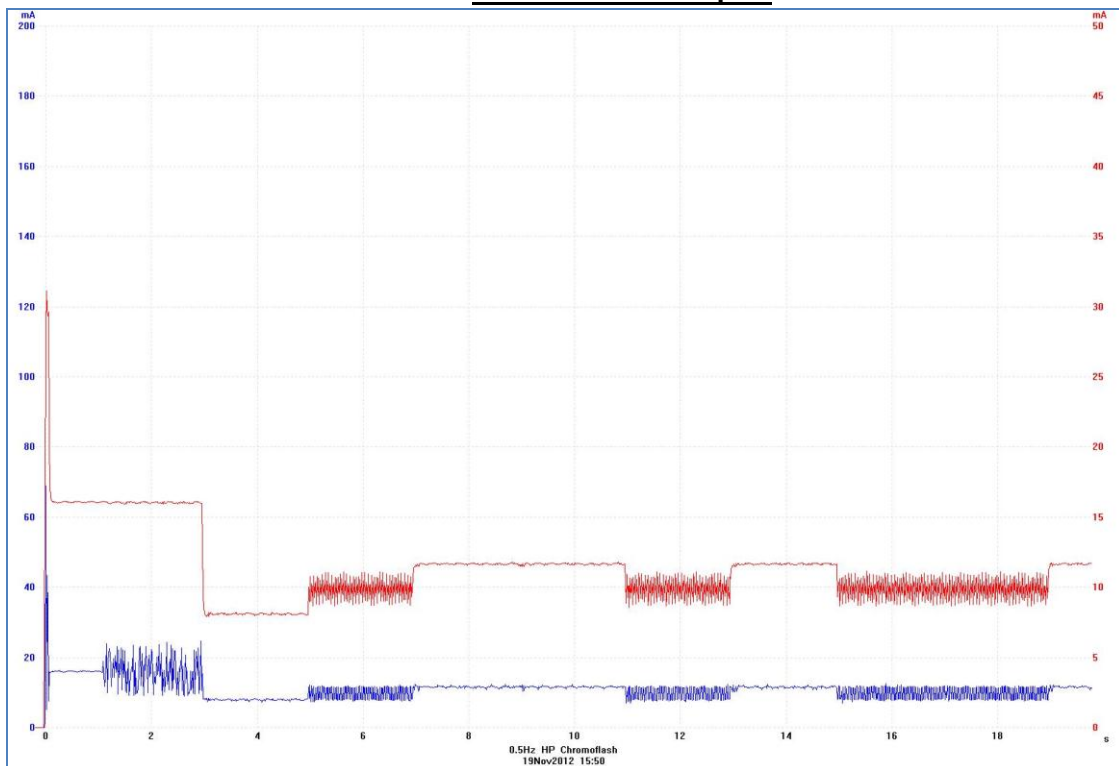

0.5Hz HP No Chromaplus

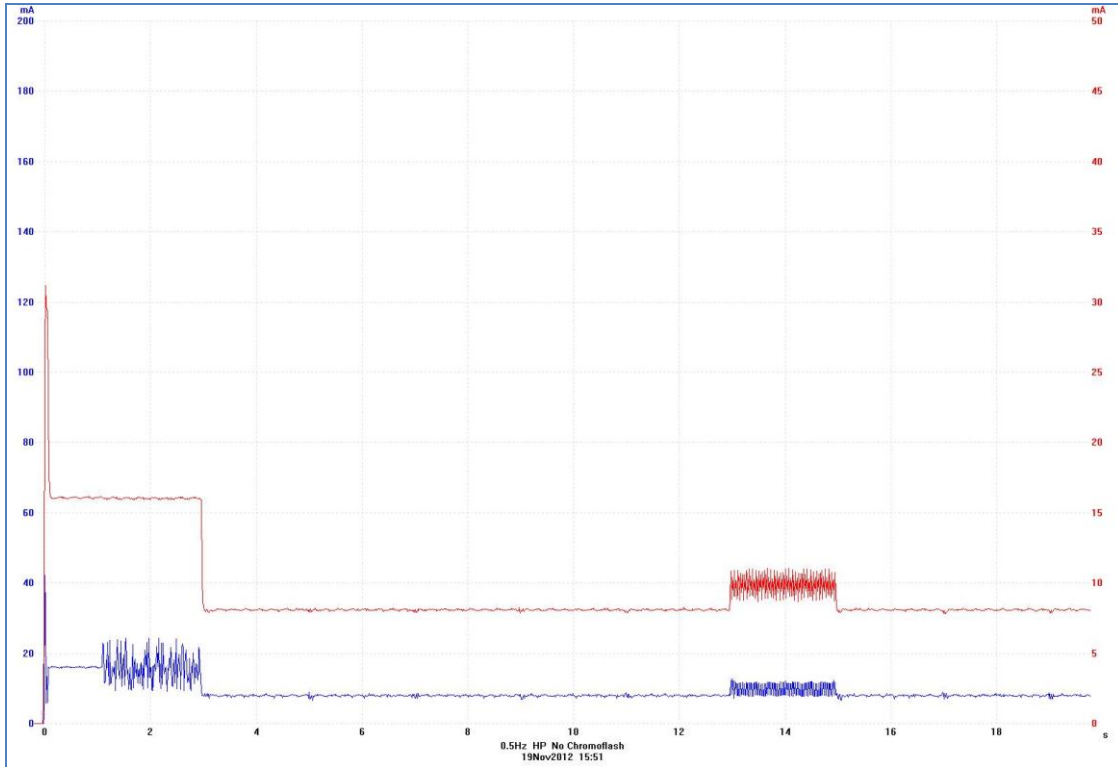

0.5Hz LP No Chromaplus

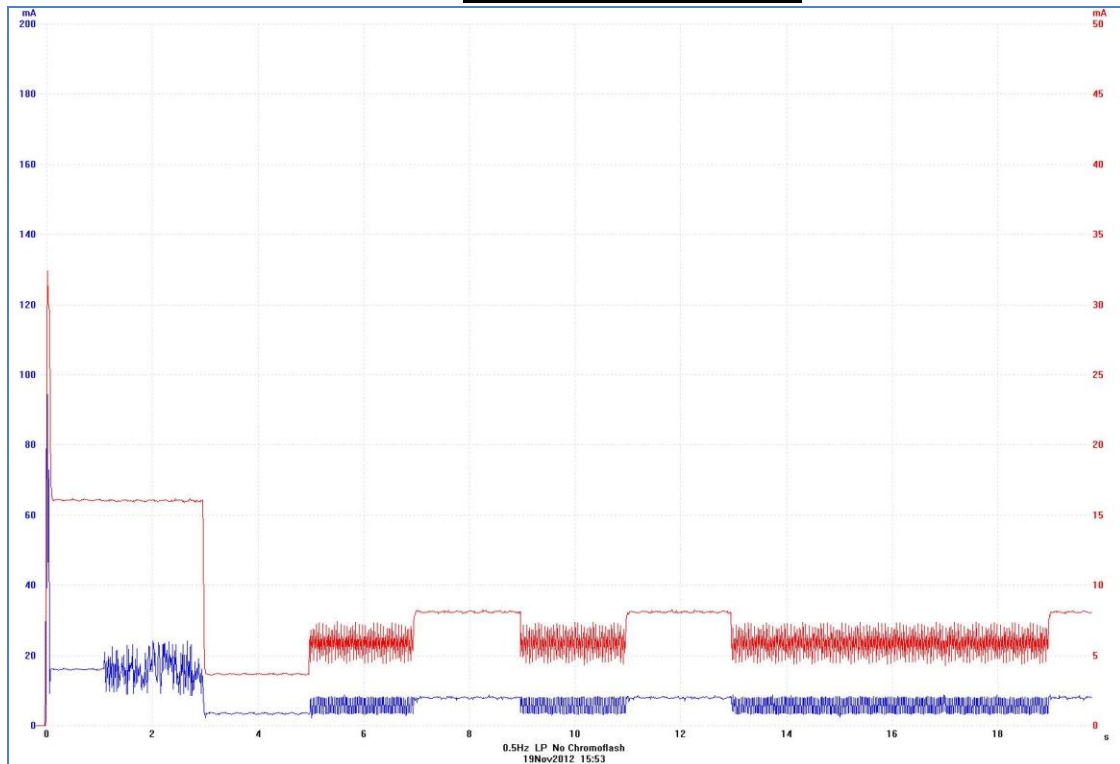

Solista LX Ceiling (White Flash): Current Consumption – V – Supply Voltage

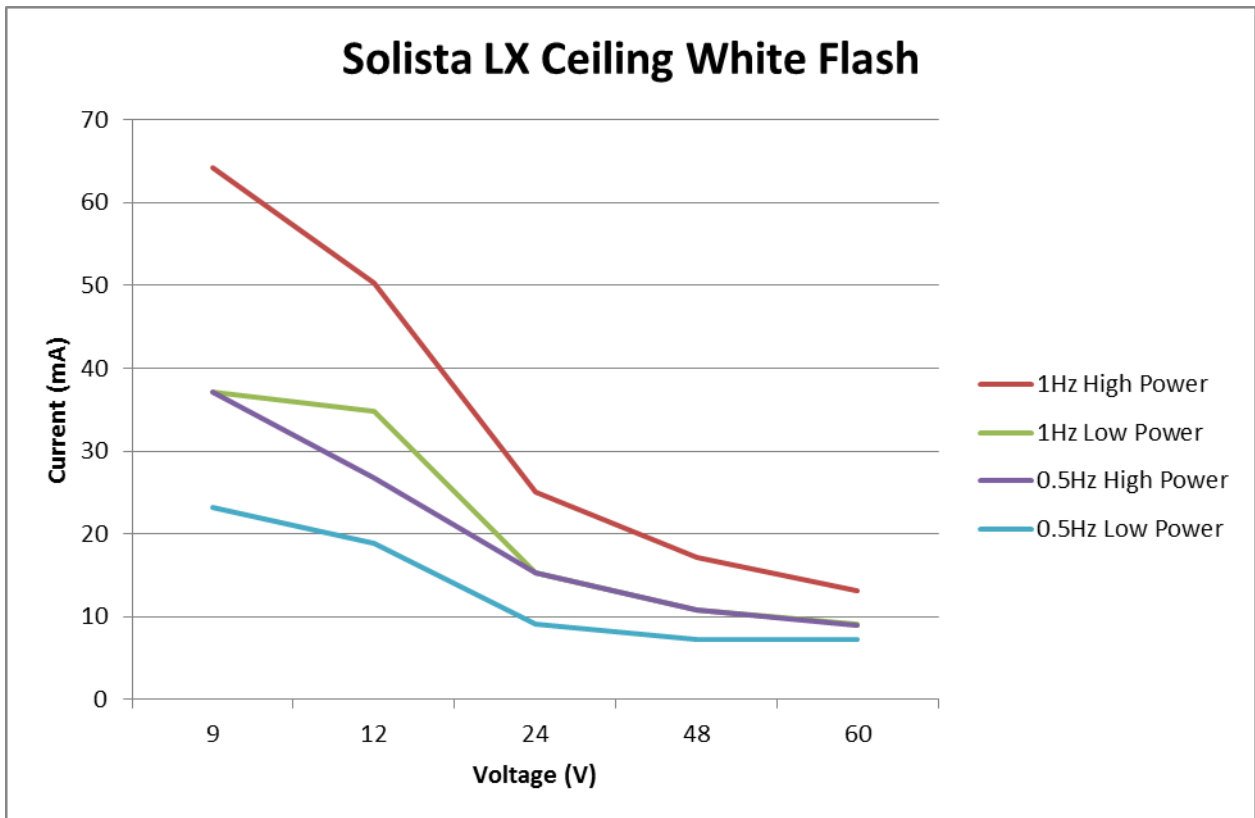

White Flash				
Voltage	1Hz High Power	1Hz Low Power	0.5Hz High Power	0.5Hz Low Power
9	64.21	37.17	37.06	23.25
12	50.35	34.86	26.74	18.87
24	25.01	15.29	15.29	9.12
48	17.11	10.88	10.88	7.29
60	13.16	9.15	8.87	7.29

Solista LX Wall (Chormaplus Flash): Current Consumption – V – Supply Voltage

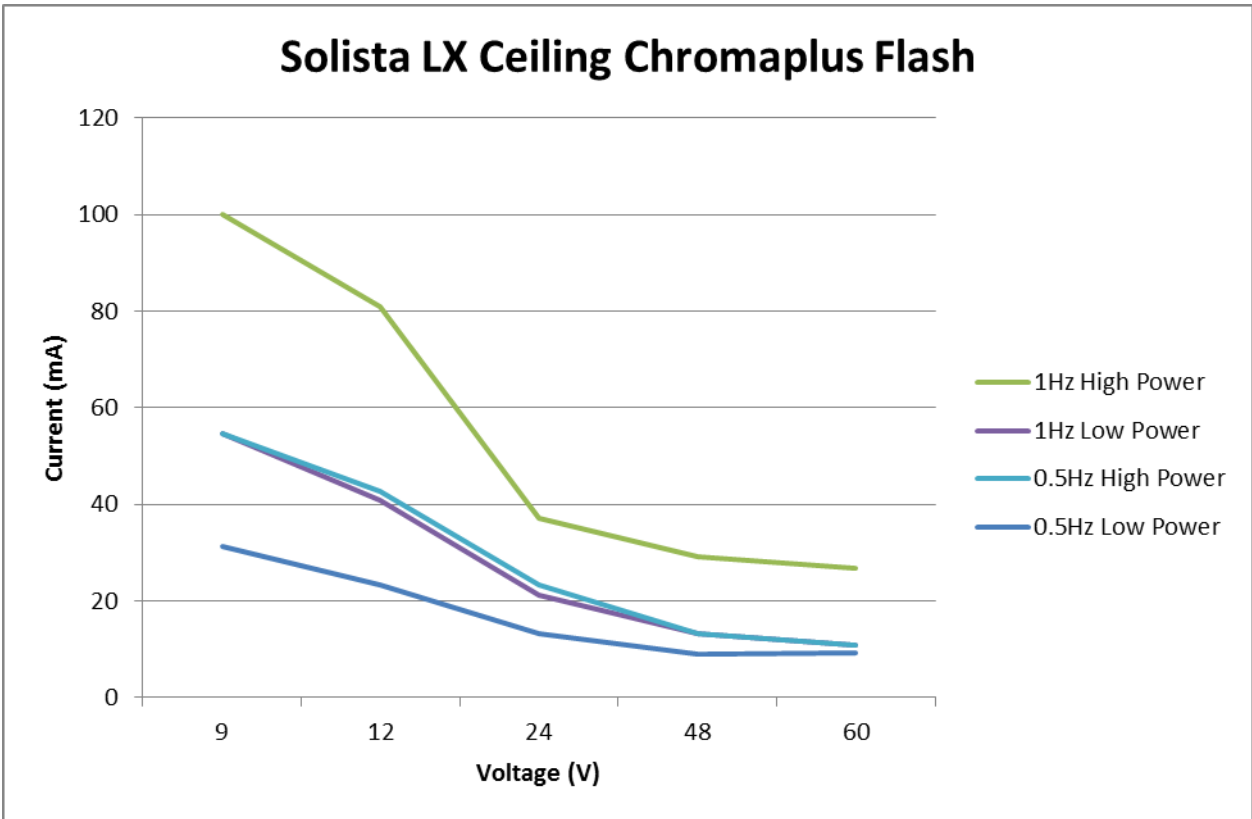

Chromaplus Flash				
Voltage	1Hz High Power	1Hz Low Power	0.5Hz High Power	0.5Hz Low Power
9	100	54.61	54.61	31.36
12	81.01	40.93	42.63	23.25
24	37.01	21.09	23.20	13.13
48	29.09	13.13	13.13	9.06
60	26.71	10.86	10.88	9.15

Solista LX Wall (Red Flash): Current Consumption – V – Supply Voltage

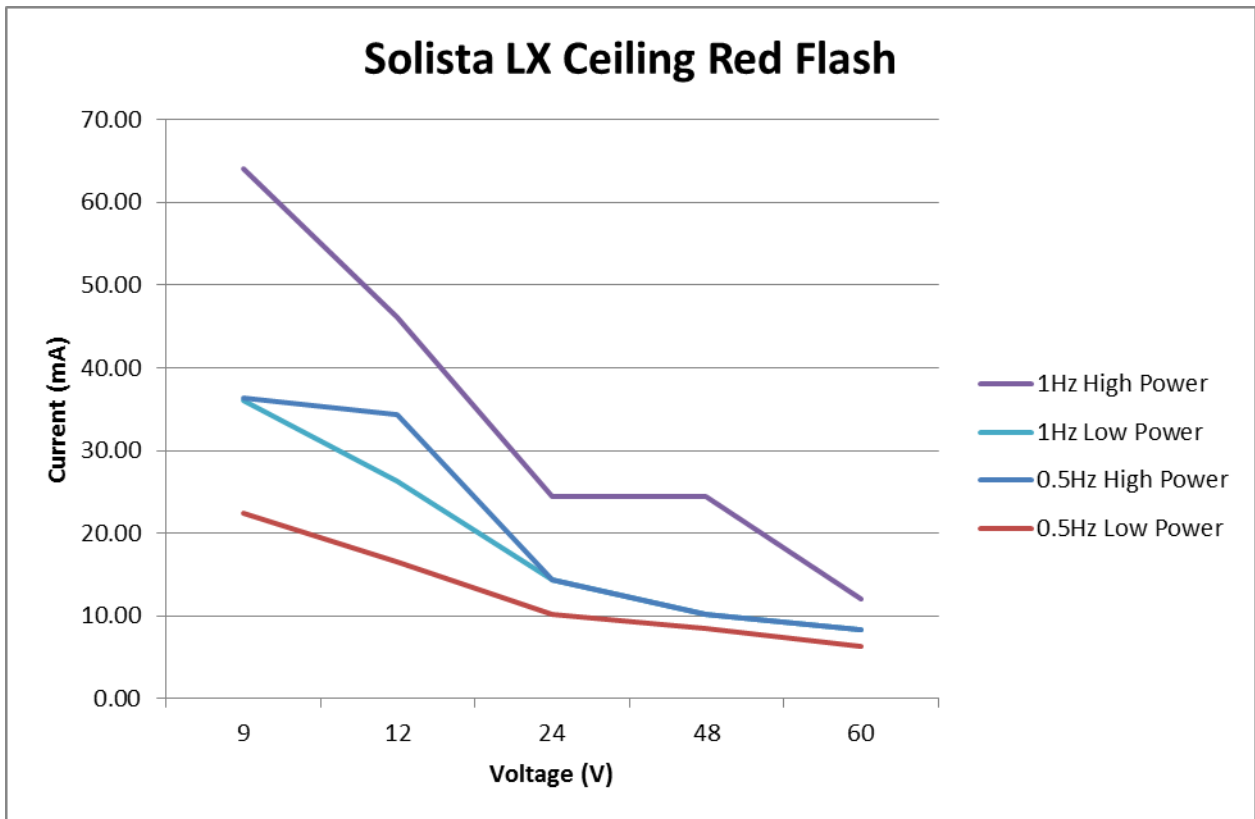

Red Flash				
Voltage	1Hz High Power	1Hz Low Power	0.5Hz High Power	0.5Hz Low Power
9	64.10	36.03	36.29	22.34
12	46.07	26.22	34.34	16.50
24	24.43	14.34	14.31	10.24
48	24.40	10.23	10.21	8.49
60	11.97	8.34	8.36	6.30

Installation Guidance & Good Practice

General Safety Guidance

- *Do not work on live circuits*
- *Follow local wiring regulations where relevant*
- *Ensure that the base is secured to the mounting surface using the most appropriate fixings. Plasterboard and hollow walls will require special anchor fixings.*

Maintaining IP (Ingress Protection) ratings – Good Practice

- *If using the product in a high humidity or damp / wet environment, it is recommended that ONLY a deep or 'U' base is used. The deep or 'U' base has a higher IP rating than the shallow base and can be used with appropriate cable glands (not included) to achieve the stated IP rating. The shallow base is only intended for INDOOR use, in low humidity environments.*
- *Use suitable cable glands (where appropriate) to maintain the designed IP rating. The stated product rating will ONLY be achieved if the product is installed correctly. A selection of suitable glands is available from all good electrical wholesalers. Always follow the cable gland instructions.*
- *Where conduit systems are used to provide cable protection, consideration should be given to appropriate drainage points, to ensure that any condensation or water droplets forming within the conduit itself are able to safely drain away, without adversely compromising any connected devices.*
- *Ensuring that all base and mounting screws are secure.*

Typical Wiring Configuration

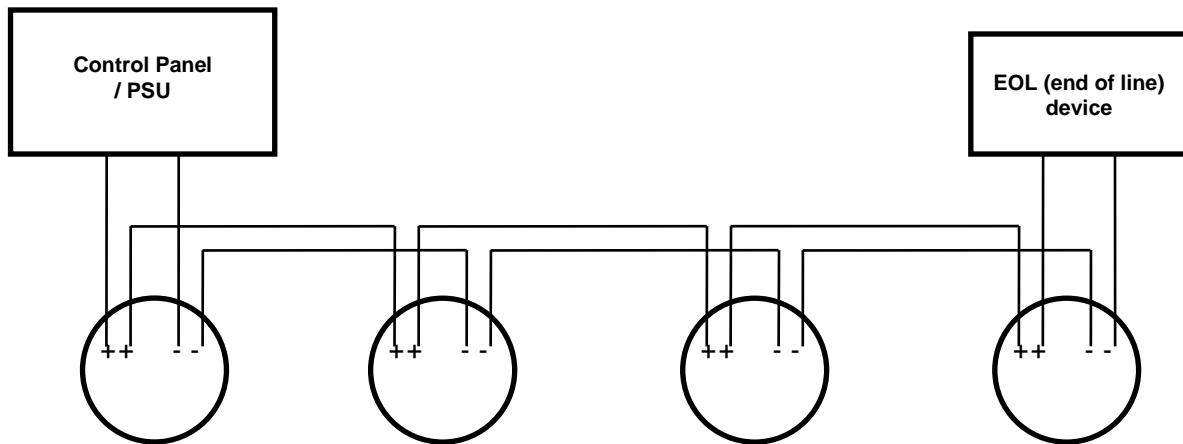

Power Supplies / Control Panels

- Use a power supply or control panel capable of providing a steady state current of at least 1.2 x the rated operating current of each device.
- Use a power supply or control panel capable of providing a surge current of at least 1.5 x the surge current of each device for at least 10mS.
- A suitable slow-blow fuse must be fitted to the output stage of all power supplies, to help prevent fuse blowing during power up.
- Where a large number of units are to be wired, it is recommended to use multiple power supplies on separate spurs or loops to avoid the huge voltage drops that would otherwise be encountered. See diagram below: -

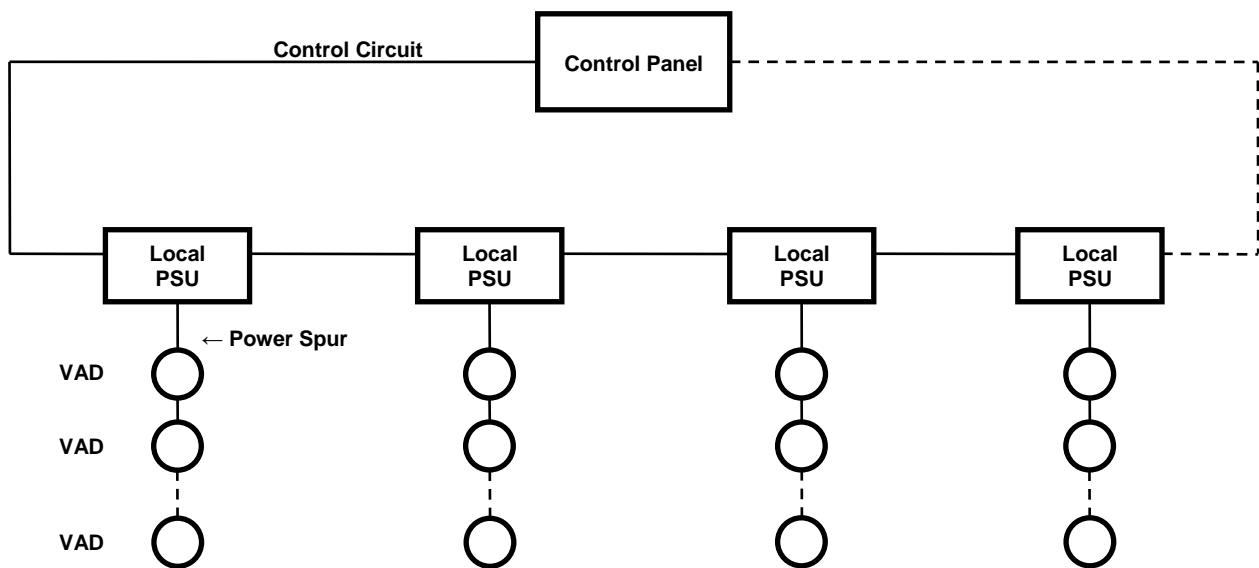

Wiring

It is important that the series resistance (R_s) of a given cable is known, as this can have a significant effect on the maximum length of the cable run possible. It is recommended that the thickest wire possible is used. This ensures that the series resistance is minimised and thus the length of the wiring that can be used is maximised.

The following table & calculations give an indication of the cable lengths that could be used with a typical setup, & are based on solid core wire with a cross sectional area (CSA) of 1.0mm². If using a different CSA, cable type, or a material other than copper is used, the value of the series resistance of the cable (R_s) can change significantly & will need to be factored into the calculations accordingly.

Please note that that all calculations here are for spurs only. It is risky to do calculations on loops, since if one side of a loop were to fail, the maximum equivalent series resistance could double. This may result in possible system start up problems or poor performance issue due to excessive voltage drops.

Typical Wiring Calculations (Solista LX Wall VAD for example purposes ONLY)

No. of products (N)	Typical max current consumption of product (I _s) - Amps	Typical power supply steady state capability (I _p) - Amps	Max cable resistance for 10% voltage drop @ 18V _{DC} (R _c) - ohms	Max cable length for 10% voltage drop @ 18V _{DC} (L) - Meters
1	0.10	0.12	^(a) 18	^(b) 500
2	0.20	0.24	9	250
3	0.30	0.36	6	167
4	0.40	0.48	4.5	125
5	0.50	0.60	3.6	100

✓ Recommendations & Assumptions:

- Cable is assumed to be copper, with core cross sectional area (CSA) of 1.0mm²
- R_s (Maximum series resistance of copper wire) = 1.8 Ω / 100meters (typical)
- Power supplies must be capable of delivering surge currents of 1.5x surge current of each device for at least 10mS
- All devices are assumed to be wired to the end of a spur (i.e. worst case scenario)
- Where the length of cable or number of devices used becomes an issue, it is recommended to group units together and use a separate power supply & wiring spur for each group

✓ Formulae:

- **Cable Resistance:**

$$R_c = V_{drop} / I_s \text{ (where } V_{drop} = 18 \times 10\%)$$

$$= 1.8V / I_s$$

$$= 1.8V / 0.10 = 18 \text{ ohm } ^{(a)}$$
- **Cable Length:**

$$L = R_c / [(R_s / 100) \times 2] \text{ (assumes feed / return (+/-) wires are same length \& diameter)}$$

$$= R_c / 0.036 \text{ ohm}$$

$$= 18 \text{ ohm} / 0.036 \text{ ohm} = 500 \text{ meters } ^{(b)}$$

* Note: All calculations and advice given is for guidance ONLY. No liability is assumed by the manufacture for the use of these calculations, or for any errors or omissions. The installer is responsible for ensuring that the product is installed and wired correctly and safely using all relevant & current wiring regulations & practices.

Maintenance

- *The product is of a low maintenance design. However, systems should be tested on a regular basis after installation. This is vital where products are used in life safety systems. Please refer to current & relevant maintenance practices.*
- *If the product is installed in a harsh environment, check seals and housing condition for any obvious signs of wear and tear or damage on a periodic basis.*
- *Cleaning of the product housing should be carried out using non-abrasive and non-corrosive substances. A lightly moistened soft cloth is usually sufficient.*

Annex A: Document Change Summary

Issue	Description Of Change	By whom	Date
1	Original document template constructed. Now waiting on R&D to add their technical information & data, to complete document.	SM	28/09/12
A	Updated with data for current consumption and coverage data. Start-up current and current consumption verses voltage updated.	PW	08/03/13
B	Updated with Red Flash Coverage	PW	06/06/13