



CDVI

Security to Access

V1SR

V3S

V3SR

V3SRB

V4S

V4SR

V4SRB

V5S

V5SR

V5SRB



V1SR



V3SR



V4SR



V5SR

Internal surface maglock



EN

SE

DK















1] GENERAL INFORMATION

- **NFS 61-937.**
- **Surface mounting.**
- **High corrosion resistance.**
- **Security rope.**
- **Delivered with armature plate.**
- **No mechanical wear.**
- **Ease of installation.**
- **Recommended for indoor use.**
- **Positive safety (frees access immediately in the event of a power cut).**
- **Holding force:** 180 - 500kg.
- **Visual and audible signalling (see table)*.**
- **No residual magnetism.**
- **Built-in electronic protection to eliminate back EMF.**

- Electromagnetic lock dimensions (L x W x D):
 - V1SR = 166 x 34 x 21mm
 - V3S series = 254 x 45 x 26mm
 - V4S series = 254 x 50 x 30mm
 - V5S series = 272 x 66 x 40mm
- Armature dimensions (L x W x D):
 - 180kg = 130 x 32 x 9mm
 - 300kg = 185 x 38 x 11mm
 - 400kg = 185 x 45 x 12mm
 - 500kg = 185 x 60 x 12mm
- Power supply: 12/24V dc.
- Power absorption:
 - 12 V DC = 500mA,
 - 24 V DC = 250mA.







The V3S, V4S and V5S series with signalling are suitable for the new regulations covering assistance to persons with reduced mobility.

| Refs | Holding force | Visual feedback | Audible feedback | Relay | Monitored |
|-------|---------------|---|------------------|-------|-----------|
| V1SR | 180kg | - | - | - | ✓ |
| V3S | 300kg |  | - | - | - |
| V3SR | 300kg |   | - | ✓ | ✓ |
| V3SRB | 300kg |   | ✓ | ✓ | ✓ |
| V4S | 400kg |  | - | - | - |
| V4SR | 400kg |   | - | ✓ | ✓ |
| V4SRB | 400kg |   | ✓ | ✓ | ✓ |
| V5S | 500kg |  | - | - | - |
| V5SR | 500kg |   | - | ✓ | ✓ |
| V5SRB | 500kg |   | ✓ | ✓ | ✓ |

Recommended power supplies



COLOUR CODES

-  **BLUE** ACTIVE VOLTAGE
-  **RED** LOCKED
-  **GREEN** OPEN
-  **BLUE** LOCKED
-  **GREEN** OPEN + BUZZER

 IP42

2] REMINDERS AND RECOMMENDATIONS

The function of an electromagnetic lock is to ensure the locking of an access point. This document is a guide of installation which will allow you to secure the installation according to the characteristics of the product, the site and the environmental requirements.

* Depending on the version.

APPROVAL RELATIVE TO EMERGENCY EXITS:

In the case of an installation of electromagnetic lock on emergency exits, it is imperative to make sure that these exit points will be automatically free in case of fire alarm, to open in the event of a fire alarm to allow evacuation of the premises. The electromagnetic lock installed on emergency exits must be in accordance with the fire approval department (Ex: In France = NF 61-937).

For more information, contact CDVI, the local fire officer or the safety officer responsible for the building.

POWER SUPPLY

An electromagnetic lock always operates in DC current, a very low safety voltage. The DiAx® electromagnetic lock is recommended for use with power supplies manufactured by CDVI, however, other power supplies may be used on condition that they are of equivalent quality and characteristics rectified, filtered, regulated and protected by fuse in primary and secondary sectors.

MOUNTING RECOMMENDATIONS

- Define the level of security of the access.
- Determine the maximum strength of holding force to this level of security.
- Select the DiAx® electromagnetic lock according to the environment, the inside, the outside, the climatic constraints, (For example: stainless steel dedicated to an outside use).
- Always install the electromagnetic lock on the secure side of the place to be secured.
- Indeed make sure that the frame and opening, receiving or supporting the electromagnetic lock, armature plate and their accessories, are solid and resistant to damage or wear over a period of time.
- Consider any bracketry required for the assembly according to the type of support receiving the electromagnetic lock and armature plate.
- Define the passage of cables to ensure the protection against the vandalism and the environmental requirements (in particular through flexible hoses of door, glands, gutters, cross cables, plastic tubes).

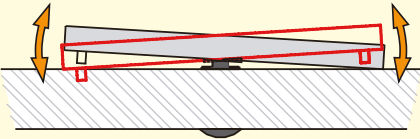

Armature plate

- It is vital to fix the electromagnetic lock and armature plate solidly on their supports.
- Make sure that the magnet and the armature meet evenly over their entire mating surfaces.
- The Armature plate must be able to pivot slightly about its center mounting screw to compensate for any door misalignment.

Security ropes

The electromagnetic lock undergoes repeated shocks and the vibration at the points of fixation on the frame (frequencies of openings / closures, attempt of opening wears closed and attempts of vandalism) which can loosen the fixing bolts/screws. To prevent the risk of the electromagnetic block from falling, install both security ropes supplied, to guarantee the safety of the users (see attached plan).

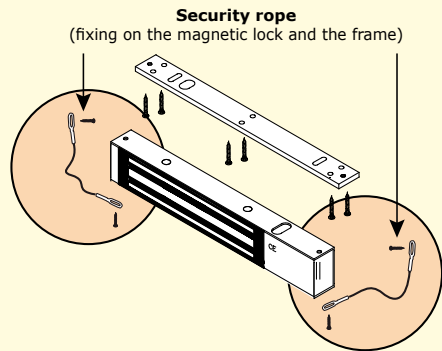











MAINTENANCE

















The Electro magnet and armature plate have a specific treatment which strengthens the protection against wear and corrosion. These products do not require high maintenance. Nevertheless to ensure optimum performance, it is recommended to clean regularly the surfaces in contact of the electro magnet and armature plate with a cloth and non abrasive products. If traces of corrosion appear, it is recommended to clean and oil the contact surfaces. Check and tighten regularly all the fixings of the Electro magnet and ensure that while the armature is able to pivot on its mounting, the fixing bolt is not liable to loosen (we recommend thread-lock for all fixing bolts).

3] PACKAGE CONTENTS





ELECTROMAGNETIC LOCK V1SR

| | | | | | | | | | | |
|--|---|---|---|---|---|---|---|---|---|--|
|  |  |  |  |  |  |  |  |  |  |  |
| Surface mount magnetic lock | Armature plate | Fixing plate | Roll pin 5x16 | Steel washer | 3x25 wood screw | Key 3mm | Guide piece | Cap nut | Installation manual | M5x20 screw |
| 1 | 1 | 1 | 2 | 2 | 5 | 1 | 1 | 1 | 1 | 1 |

ELECTROMAGNETIC LOCK V3S, V4S AND V5S - SERIES

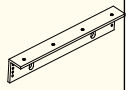
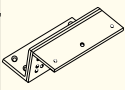
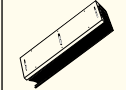
| | | | | | | | |
|--|---|---|---|---|---|---|--|
|  |  |  |  |  |  |  |  |
| Surface mount magnetic lock | Armature plate | Fixing plate | Roll pin 5x16 | Steel washer | 4x25 wood screw | Key 3mm | Key 5mm |
| 1 | 1 | 1 | 2 | 2 | 7 | 1 | 1 |
|  |  |  |  |  |  |  |  |
| M8x35 screw | M8x25 screw | 3x8 self-tapping screw | Guide piece | Cap nut | Safety rope | Rubber washer | Installation manual |
| 1 | 1 | 1 | 1 | 1 | 2 | 1 | 1 |

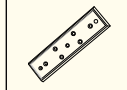
4] OPTIONAL ACCESSORIES

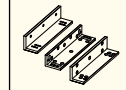
| | | | | | | | |
|--------------------|---|---|---|---|---|---|--|
| |  |  |  |  |  |  |  |
| References | L3L4L5 | Z3Z4Z5 | UBKU | UBKP | AMA3AMA5 | DPM300 DPM500 | LZ1 |
| Description | L-shaped bracket for lock | Z-shaped bracket for lock | Armature base for glass door | Universal base for glass door | Armature base | Door position monitoring | L & Z-shaped bracket for 180kg lock |

5] ELECTRICAL CONNECTIONS

| TERMINAL BLOCK | CORRESPONDENCE | V3S V4S - V5S | V3SR - V3SRB - V4SR V4SRB - V5SR - V5SRB |
|----------------|----------------------|------------------|---|
| + | 12 or 24V dc | ■ | ■ |
| - | - 0 V | ■ | ■ |
| N.C | NC (Normally closed) | - | ■ |
| COM | COM | - | ■ |
| N.O | NO (Normally open) | - | ■ |



12V dc
Factory
Setup

The NO/NC signal only switches when the door is closed with the power to it on.

WITH BUILT-IN PCB BOARD

V1SR

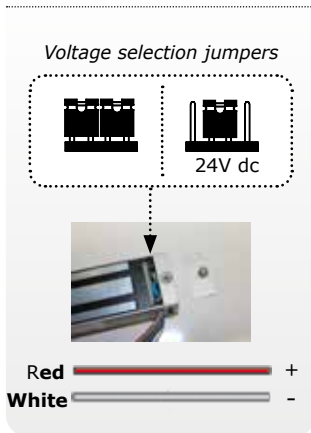

V3S__ - V4S__ - V5S__

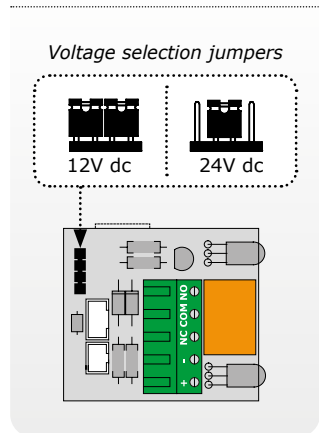

DIRECT CONNECTION

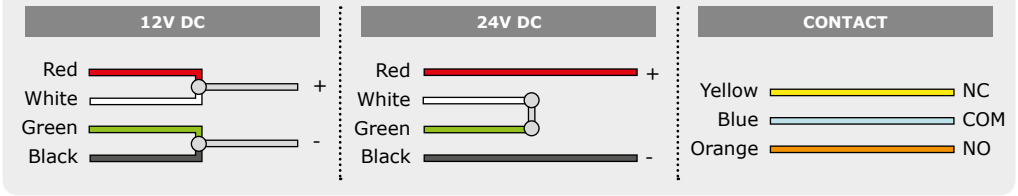

IMPORTANT NOTE

Check the jumper position before connecting the lock to the input current. A wrong position could damage the lock. This type of damage is not covered by the warranty.

6] INSTALLATION (EXAMPLE: V3S SERIES)

Installation on an outward opening door (Push door)

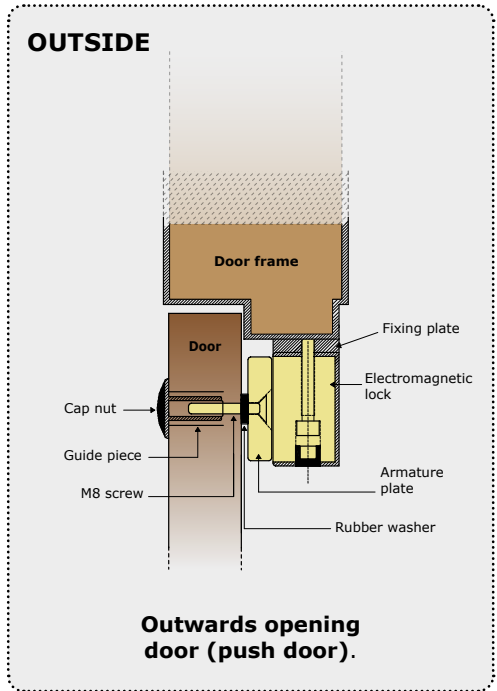
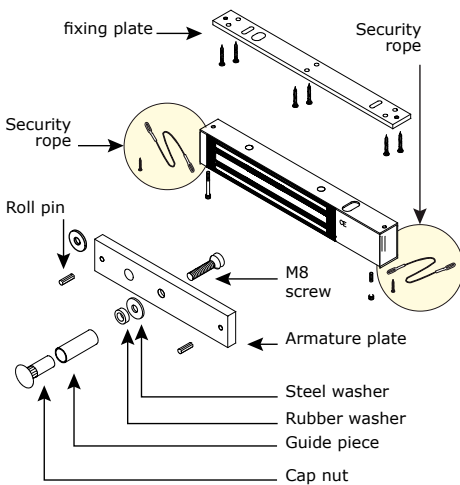

Installation on an inward opening door (Pull door)

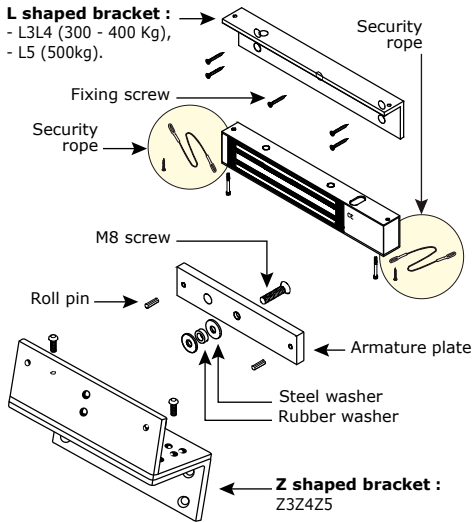
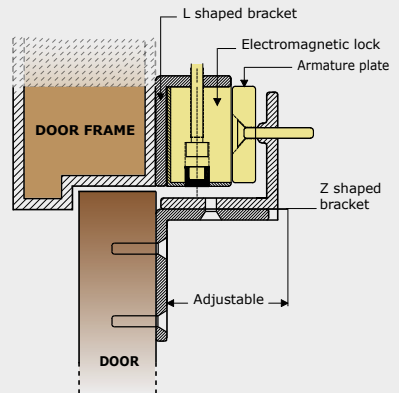
OUTSIDE
INSIDE

Inward opening door (Pull door)
 (installed with "Z" and "L" brackets)

7] INSTALLATION WITH ACCESSORIES

Installation with an Armature housing

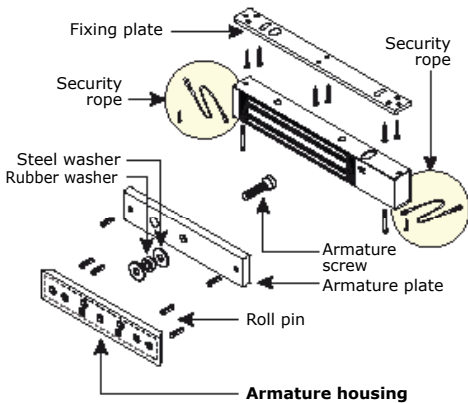
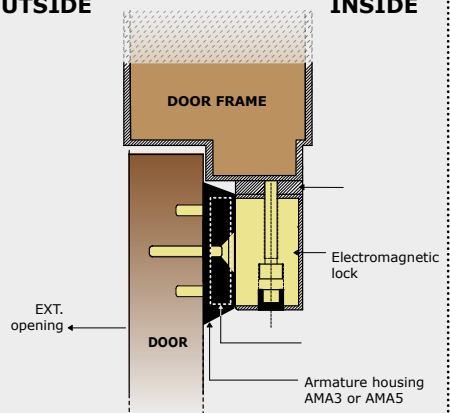
OUTSIDE
INSIDE

Outwards opening door (push door).
 (installed with armature housing)

Installation with base for glass door

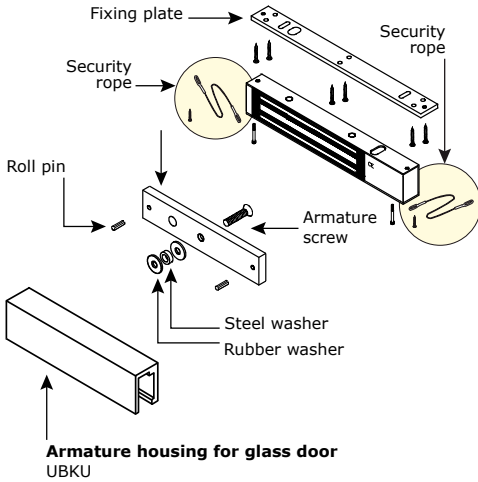

OUTSIDE

INSIDE

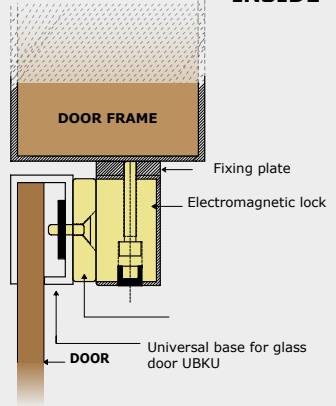

Outward opening door (Push door)
(installed with UBKU brackets)

Installation with base for glass door

L shaped bracket :
- L3L4 (300 - 400 Kg),
- L5 (500kg).

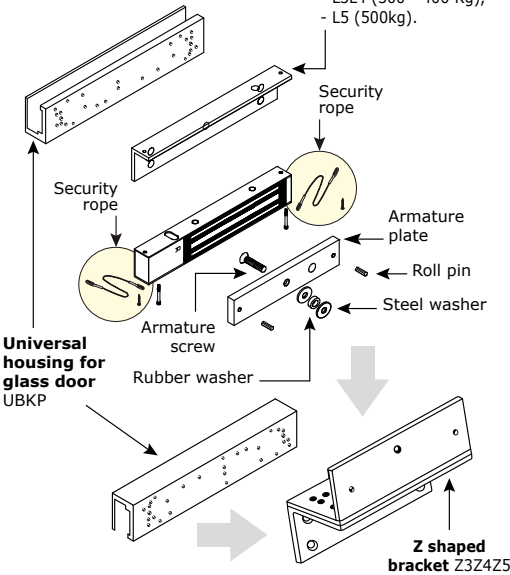

OUTSIDE

INSIDE

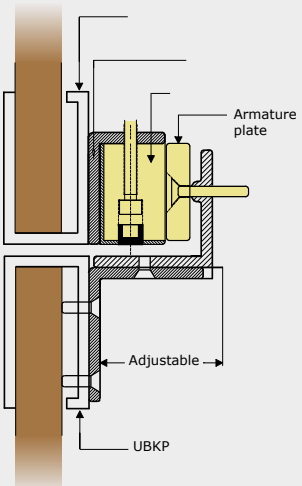

Inward opening door (Pull door)
(installed with "UBKP", "L3L4L5"
and Z3Z4Z5 brackets)

Installation with DPM300 - DPM400 - DPM500 (Door position monitoring)*

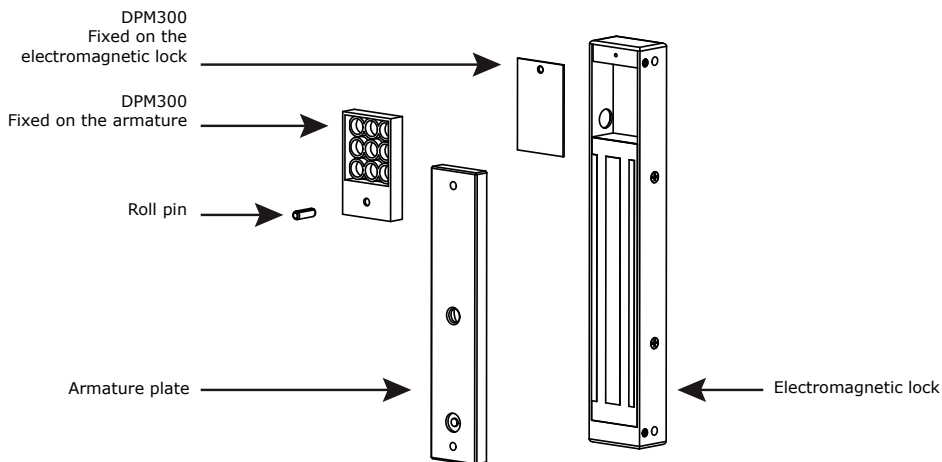

8] FAULT FINDING

| PROBLEM | POSSIBLE CAUSE | SOLUTION |
|--------------------------------|---|--|
| Door locking impossible | The lock is not receiving DC current. | <ul style="list-style-type: none"> - Check that the wires are connected to the right terminals. - Check that the power supply is compatible. - Check that the lock is connected to the circuit correctly. |
| Holding force reduced | The lock and the armature are not lined up with each other. | <ul style="list-style-type: none"> - Check that the lock is connected to the circuit correctly. - Check that the electromagnet and the armature are properly aligned. - Check that the contact faces are free from dirt and rust. - Check that the armature is soft mounted. |
| | Low voltage or armature jammed. | <ul style="list-style-type: none"> - Check that the lock is receiving the correct power supply satisfactorily. - check the tightening of the armature and the condition of the rubber. |
| Faulty reed switch | Voltage too low. Misalignment. | <ul style="list-style-type: none"> - Check the power supply. - Cable cross section to be determined according to the power supply and the locking. - e.g.: $2 \times 1.5\text{mm}^2 \geq 10\text{m}$. |

* Optional. Sold separately.









1] PRODUKTSPECIFIKATION

- **NFS 61-937.**
- **Utänpåliggande montage.**
- **Korrisionskyddad.**
- **Inkluderad säkerhetsvajer.**
- **Levereras med ankarplatta.**
- **Inget mekaniskt slitage.**
- **Enkel installation.**
- **Rekommenderas för inomhusbruk.**
- **Säkerheten först (Låser upp direkt vid stömbortfall).**
- **Hållkraft:** 180 - 500kg.
- **Ljud- och ljusindikering (se tabellen)*.**
- **Ingen remenans.**
- **Inbyggt elektronikskydd.**

- Elektromagnetens dimensioner (L x B x H):
 - V1SR = 166 x 34 x 21mm
 - V3S serien = 254 x 45 x 26mm
 - V4S serien = 254 x 50 x 30mm
 - V5S serien = 272 x 66 x 40mm
- Ankarplattans dimensioner (L x B x H):
 - 180kg = 130 x 32 x 9mm
 - 300kg = 185 x 38 x 11mm
 - 400kg = 185 x 45 x 12mm
 - 500kg = 185 x 60 x 12mm
- Spänningsmatning: 12/24V dc.
- Strömförbrukning:
 - 12 V DC = 500mA,
 - 24 V DC = 250mA.



V3S, V4S och V5S serien är lämpad enligt den nya standarden kring tillgänglighet för människor med nedsatt rörlighet

| Produkt | Hållkraft | LED | Summer | Ljusindikering | Status |
|---------|-----------|---|--------|----------------|--------|
| V1SR | 180kg | - | - | - | ✓ |
| V3S | 300kg |  | - | - | - |
| V3SR | 300kg |  | - | ✓ | ✓ |
| V3SRB | 300kg |  | ✓ | ✓ | ✓ |
| V4S | 400kg |  | - | - | - |
| V4SR | 400kg |  | - | ✓ | ✓ |
| V4SRB | 400kg |  | ✓ | ✓ | ✓ |
| V5S | 500kg |  | - | - | - |
| V5SR | 500kg |  | - | ✓ | ✓ |
| V5SRB | 500kg |  | ✓ | ✓ | ✓ |

Rekommenderade nättaggregat



FÄRGER

-  BLÅ SPÄNNING
-  RÖD LÅST
-  GRÖN OLÅST
-  BLÅ LÅST
-  GRÖN OLÅST+SUMMER

IP42

2] INFORMATION OCH REKOMMENDATIONER

Elektromagnetens funktion är att öka säkerheten genom att se till att passerkontrollen är ordentligt låst. Det här är en installationsguide som ger vägledning hur man anpassar installationen efter rådande förutsättningar med avseende på produkten, platsen den placeras på och den omgivande miljön samtidigt som man uppnår största möjliga säkerhetsnivå.

* Beroende på version

STANDARD FÖR NÖDUTGÅNGAR

Om en elektromagnet monteras vid en nödutgång är det nödvändigt att kontrollera att dörren automatiskt låses upp vid ett brandlarm för att möjliggöra evakuering. En elektromagnet som sitter på en nödutgång måste installeras i enlighet med gällande brandsäkerhetslagar och förordningar (Ex : SS-EN1155).

För mer information, kontakta CDVI, svenska brandskyddsföreningen eller säkerhetsansvarig för byggnaden.

STRÖMFÖRSÖRJNING

En elektromagnet drivs alltid med likström (DC), en säker svagströms matning. Det rekommenderas att Diax® elektromagneter används tillsammans med nättaggregat tillverkade av CDVI. Det går att använda andra nättaggregat om de uppfyller kraven på motsvarande kvalitet och egenskaper, - likriktad, filtrerad, reglerad och med dubbelautomatsäkring (primär och sekundär).

MONTERINGSINSTRUKTIONER

- Bestäm säkerhetsnivån på passerkontrollen.
- Den maximala styrkan på hållkraften anpassas till vald säkerhetsnivå.
- Välj Diax® elektromagnet utifrån omgivningen, interiört, exteriört, klimat förutsättningar, ... (Till exempel : rostfritt stål för utomhusbruk).
- Installera alltid elektromagneten på insidan på en säker plats.
- Kontrollera att dörrposten och dörrkarmen, som stöttar eller håller elektromagneten, ankarplattan med tillbehör, är robusta och står emot slitage över tid.
- Välj fästen utifrån funktion och dörrkarm som elektromagneten och ankarplattan skall monteras på.
- Bestäm hur kablar ska dras på ett säkert sätt för att skyddas från vandalisera och olika väderförhållanden (t ex genom flexibla karmöverföringar, kabelrännor, plastror, ...).

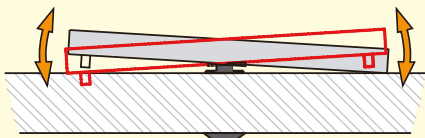

Ankarplattan

- Det är mycket viktigt att elektromagneten och ankarplattan är ordentligt fästa i underlaget.
- Se till att elektromagneten och ankarplattan möts jämnt fördelat över hela kontaktytan för att optimera hållkraften.
- Ankarplattan måste kunna vicka runt monteringskruven i mitten, för att kompensera om dörren inte är helt rak.

Säkerhetsvagnar

Elektromagnetens fästen utsätts för upprepade vibrationer och andra påfrestningar under sin livstid. Öppningsfrekvensen, stängningar, försök att öppna låst dörr samt vandaliseringsförsök orsakar slitningar och kan resultera i att monteringskruvarna blir lösa. För att förhindra elektromagneten från att falla ner montera de två säkerhetsvagnarna som följer med. Detta för att garantera säkerheten för användarna (se bild).

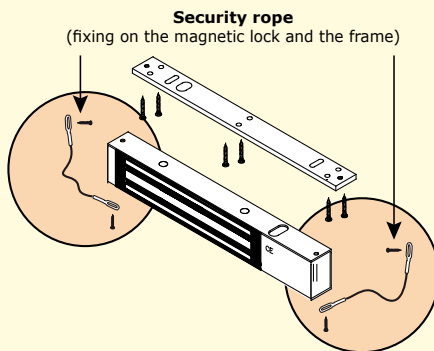















SKÖTSEL

Elektromagneten och ankarplattan är specialbehandlade för att motstå rostbildning och slitage. De här produkterna kräver inte mycket underhåll. För maximal effekt bör kontaktytorna på elektromagneten och ankarplattan torkas regelbundet med en trasa och mildt rengöringsmedel. Om spår av rost uppstår, rekommenderar vi att kontaktytorna rengörs och oljas in. Kontrollera och skruva åt alla monteringskruvorna på elektromagneten regelbundet. Kontrollera även att ankarplattan kan vicka runt monteringskraven. Vi rekommenderar att låsbrickor används till alla monteringskruvorna.



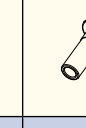

3] MONTERINGSSATS
ELEKTROMAGNET V1SR

| | | | | | | | | | | |
|--|---|---|---|---|---|---|---|---|--|---|
|  |  |  |  |  |  |  |  |  |  |  |
| Elektromagnet | Ankarplatta | Monteringsfäste | Styrpinne 5x16 | Bricka | Skruv M5x20 | Träskruv 3x25 | Nyckel 3 mm | Distanshylsa | Fästbult | Manual |
| 1 | 1 | 1 | 2 | 2 | 1 | 5 | 1 | 1 | 1 | 1 |

ELEKTROMAGNETERNA V3S, V4S OCH V5S - SERIEN

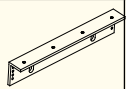
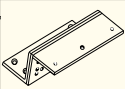
| | | | | | | | |
|--|---|---|---|---|---|---|---|
|  |  |  |  |  |  |  |  |
| Elektromagnet | Ankarplatta | Monteringsfäste | Styrpinne 5x16 | Bricka | Träskruv 4x25 | Nyckel 3 mm | Nyckel 5 mm |
| 1 | 1 | 1 | 2 | 2 | 7 | 1 | 1 |
|  |  |  |  |  |  |  |  |
| Skruv M8x35 | Skruv M8x25 | Självgängande skruv 3x8 | Distanshylsa | Fästbult | Säkerhetsvajer | Gummibricka | Manual |
| 1 | 1 | 1 | 1 | 1 | 2 | 1 | 1 |

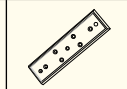
4] TILLBEHÖR

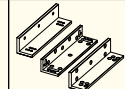
| | | | | | | | |
|--------------------|---|---|---|---|---|---|--|
| |  |  |  |  |  |  |  |
| Produkt | L3L4 (300KG) L5 (500KG) | Z3Z4Z5 | UBKU | UBKP | AMA3 AMA5 | DPM300 DPM500 | LZ1 |
| Beskrivning | "L"-format vinkelfäste (300,400 & 500kg) | "Z"-format vinkelfäste (300,400 & 500kg) | Monteringsplatta (ankarplatta) - glasdörr (300,400 & 500kg) | Monteringsplatta (elektromagnet) - glasdörr (300,400 & 500kg) | Monteringsplatta (ankarplatta) (300 & 500kg) | Dörrpositions-in- dikering (300 & 500kg) | Monteringsatts: vinkelfästen L & Z för V1SR (180 kg) |

5] INKOPPLINGAR

| PLINT | INKOPPLING | V3S V4S - V5S | V3SR - V3SRB - V4SR V4SRB - V5SR - V5SRB |
|------------|----------------------|------------------|---|
| + | 12 eller 24V dc | ■ | ■ |
| - | - 0 V | ■ | ■ |
| N.C | NC (Normally closed) | - | ■ |
| COM | COM | - | ■ |
| N.O | NO (Normally open) | - | ■ |



**Fabriks-
inställ-
ning
12 V**

NO/NC signalen växlar endast när magnetlåset är lås, inte när dörren är stängd.

PÅ KRETSKORTET

V1SR

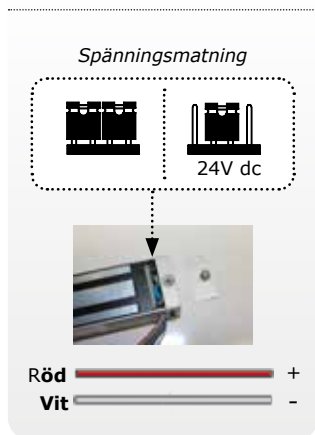

V3S__ - V4S__ - V5S__

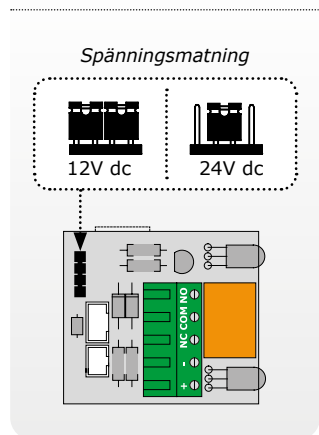

ANSLUTNING UTAN KRETSKORT

12V DC

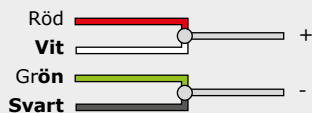

24V DC

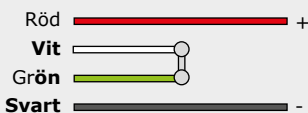

CONTACT



VIKTIGT

Kontrollera att byglingen sitter rätt innan elektromagneten förses med ström. En felaktigt placerad byggel kan skada elektromagneten. Den här typen av skada täcks inte av garantin.

6] MONTERING (EXEMPEL: V3SR)

Montering på dörr som öppnas utåt (slagdörr)

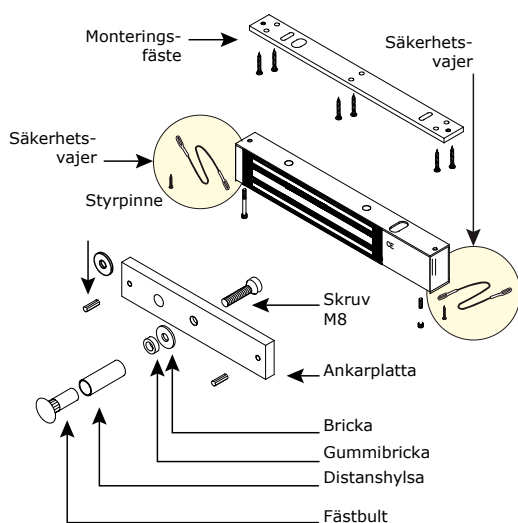

UTOMHUS

INOMHUS

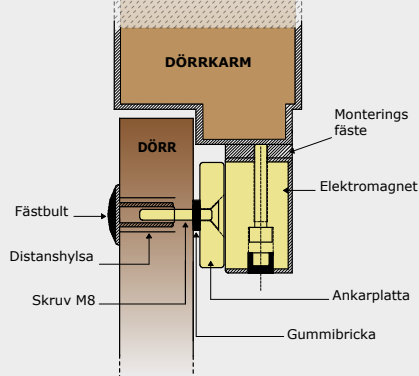

Utåtgående dörr (Slagdörr)

7] INSTALLATION MED TILLBEHÖR

Montering på dörr som öppnas inåt

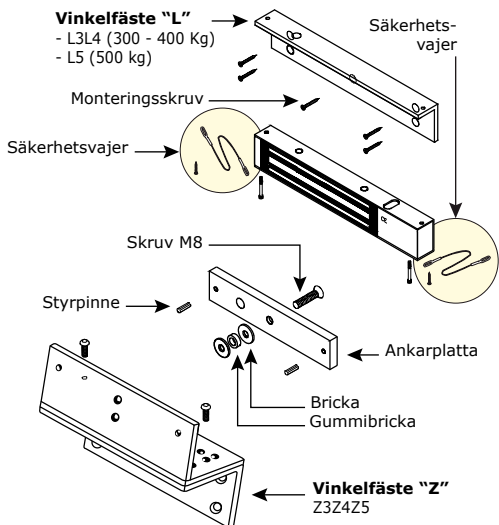

UTOMHUS

INOMHUS

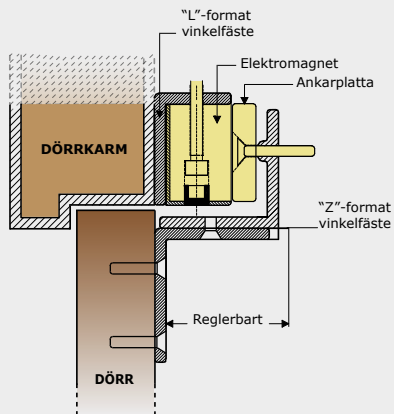

Inåtgående dörr

(installerade med "L" och "Z" vinkelfästen).

Installation med monteringsplatta för ankarplattan

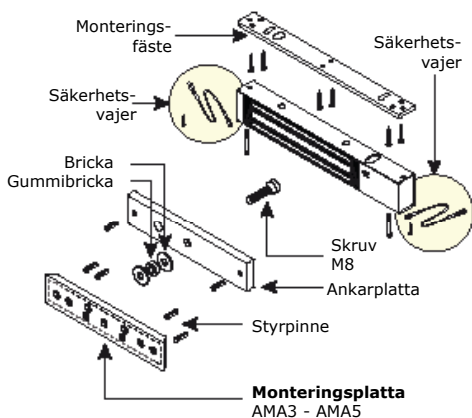

UTOMHUS

INOMHUS

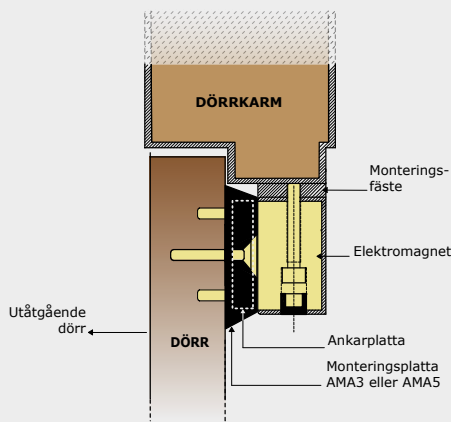

Dörr som öppnas utåt

Installation med monteringsfäste för glassdörr

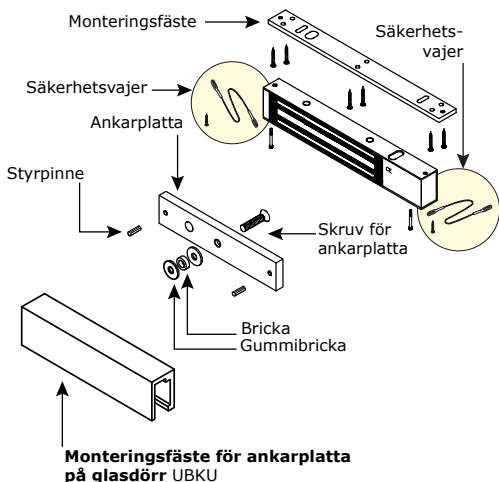

UTOMHUS

INOMHUS

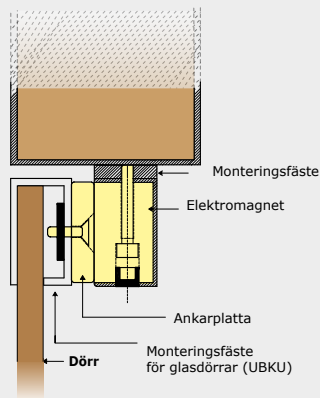

Utåtgående dörr (installerad med monteringsfäste för glassdörrar UBKU).

Installation med fästen för glassdörrar

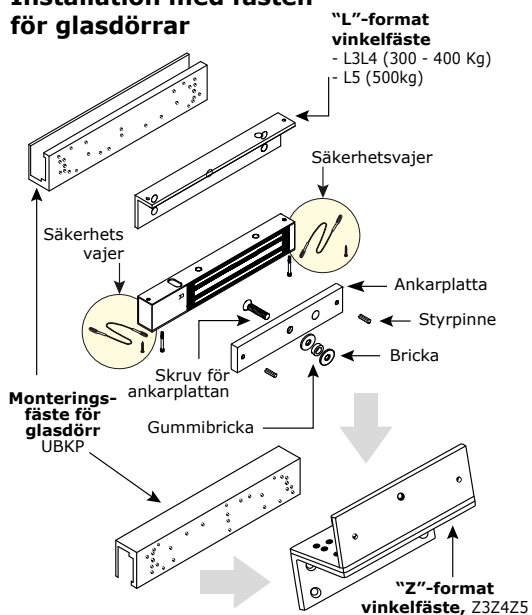

UTOMHUS

INOMHUS

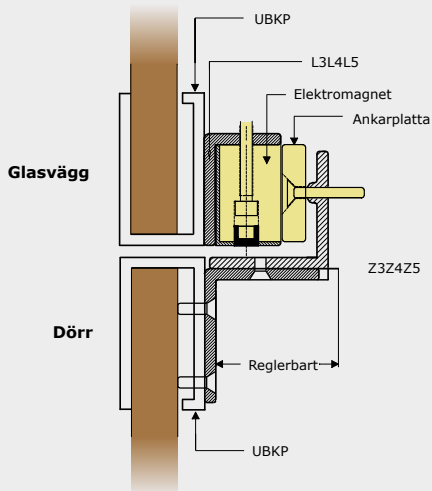

Inåtgående dörr (installerad med monteringsplatta för ankarplattan på glassdörr, samt med "Z"-format vinkelfäste för elektromagneten på glassdörrar).

INSTALLATION MED DPM300 - DPM400 - DPM500 (Magnetkontakt)*

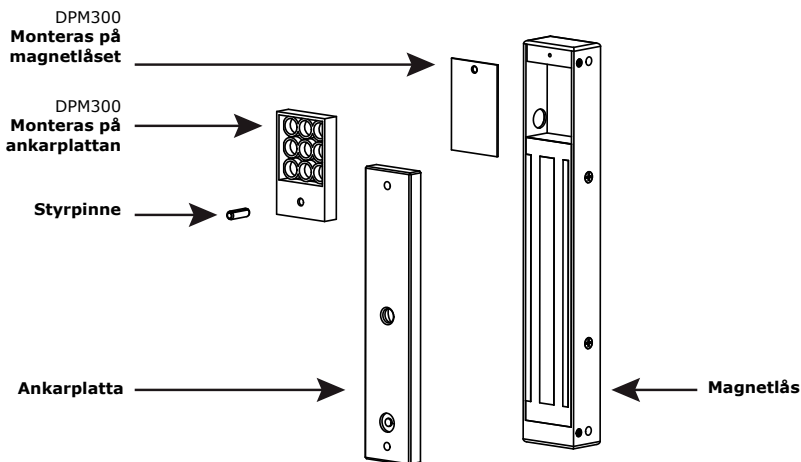

8] FELSÖKNING

| PROBLEM | TROLIG ORSAK | LÖSNING |
|---------------------------------|--|--|
| Dörren går inte att låsa | Elektromagneten får inte matarspänning DC. | <ul style="list-style-type: none"> - Kontrollera att kablarna är anslutna till rätt utgångar på kopplingsplinten. - Kontrollera att nätaggregatet är rätt dimensionerat. - Kontrollera att elektromagneten får rätt spänningsmatning. |
| Hållkraften nedsatt | Elektromagneten och ankarplattan är inte helt parallella med varandra. | <ul style="list-style-type: none"> - Kontrollera att elektromagneten får rätt spänningsmatning. - Kontrollera att elektromagneten och ankarplattan är parallella och möts ordentligt. - Kontrollera att kontaktytorna är rena och fria från rost. - Kontrollera att ankarplattan kan vicka (runt skruven). |
| | Låg spänningsmatning, eller ankarplattan övertäckt. | <ul style="list-style-type: none"> - Kontrollera att elektromagneten får rätt spänningsmatning. - Kontrollera att ankarplattan är fäst ordentligt och även att delarna av gummi är mjuka. |
| Felaktig indikering | För låg spänningsmatning. Kontaktytorna möts inte helt. | <ul style="list-style-type: none"> - Kontrollera nätaggregatet. - Kontrollera kabelns dimensioner mellan nätaggregatet och elektromagneten. - ex: $2 \times 1,5\text{mm}^2 \geq 10\text{m}$ |

* Valfritt. Säljes separat.









1] PRODUKTSPECIFIKATION

- **NFS 61-937.**
- **Overflademontage.**
- **Korrosionsbeskyttet.**
- **Sikkerhedswirer inkluderet.**
- **Leveres med ankerplade.**
- **Ingen mekanisk slitage.**
- **Nem at installere.**
- **Anbefales til indendørsbrug.**
- **Sikkerheden først (låser øjeblikkelig op ved strømafbrydelse).**
- **Holdekraft:** 180 - 500kg.
- **Lyd- og lysindikering (se tabel).***
- **Ingen remenans**
- **Indbygget elektronikbeskytter (for at eliminere EMF-stråling)**

- Elektromagnetens dimensioner (L x W x D):
 - V1SR = 166 x 34 x 21 mm.
 - V3S-serie = 254 x 45 x 26 mm.
 - V4S-serie = 254 x 50 x 30 mm.
 - V5S-serie = 272 x 66 x 40 mm.
- Ankerpladens dimensioner (L x W x D):
 - 180 kg = 130 x 32 x 9 mm.
 - 300 kg = 185 x 38 x 11 mm.
 - 400 kg = 185 x 45 x 12 mm.
 - 500 kg = 185 x 60 x 12 mm.
- Strømforsyning: 12 / 24V DC.
- Strømforbrug:
 - 12 V DC = 500 mA.
 - 24 V DC = 250 mA.



V3S-, V4S- og V5S-serierne er tilpasset kravene i den nye standard for tilgængelighed for personer med nedsat bevægelighed.

| Pro-duk-t | Holde-kraft | LED | Summer | Relæ | Status |
|-----------|-------------|---|--------|------|--------|
| V1SR | 180kg | - | - | - | ✓ |
| V3S | 300kg |  | - | - | - |
| V3SR | 300kg |  | - | ✓ | ✓ |
| V3SRB | 300kg |  | ✓ | ✓ | ✓ |
| V4S | 400kg |  | - | - | - |
| V4SR | 400kg |  | - | ✓ | ✓ |
| V4SRB | 400kg |  | ✓ | ✓ | ✓ |
| V5S | 500kg |  | - | - | - |
| V5SR | 500kg |  | - | ✓ | ✓ |
| V5SRB | 500kg |  | ✓ | ✓ | ✓ |

Anbefalede strømforsyninger



FARVEKODER

-  **BLÅ** AKTIV SPÆNDING
-  **RØD** LÅST
-  **GRØN** ÅBEN
-  **BLÅ** LÅST
-  **GRØN** ÅBEN + SUMMER

 IP42

2] INFORMATION OG ANBEFALINGER

En elektromagnetisk lås sikrer, at en adgangskontrol er korrekt låst, og øger dermed sikkerheden. Denne installationsguide giver vejledning i, hvordan installationen kan tilpasses de gældende forhold, hvad angår selve produktet, det sted, det placeres, og det omgivende miljø, så der samtidig opnås det højst mulige sikkerhedsniveau.

* Afhængigt af versionen.

STANDARD FOR NØDUDGANGE

Hvis en elektromagnetisk lås er monteret ved en nødudgang, er det bydende nødvendigt at sikre sig, at døren i tilfælde af en brandalarm automatisk låses op og dermed muliggør evakuering. En elektromagnet, der er placeret på en nødudgang, skal installeres i overensstemmelse med gældende brandsikkerhedslove og -forskrifter (Ex: SS-EN1155).

For mere information, kontakt CDVI, de lokale brandmyndigheder eller bygningens sikkerhedsansvarlige.

STRØMFORSYNING

En elektromagnetisk lås kører altid på jævnstrøm (DC), som er en sikker lav strømforsyning. Det anbefales, at Diax®-elektromagneter bruges sammen med strømforsyninger fremstillet af CDVI. Andre strømforsyninger kan bruges, hvis de opfylder kravene til ækvivalent kvalitet og har de samme egenskaber – dvs. er udbedret, filtreret, reguleret og med dobbelt automatsikring (primær og sekundær).

MONTAGEANVISNING

- Bestem sikkerhedsniveauet for adgangskontrollen.
- Holdekraftens maksimale styrke justeres til det valgte sikkerhedsniveau.
- Vælg Diax® elektromagneten på baggrund af omgivelserne, interiør, eksteriør eller klimaforhold (for eksempel: rustfrit stål til udendørsbrug).
- Installer altid magnetlåsen på den sikre side (undersiden) af det sted, der skal sikres.
- Kontroller, at dørrammen, der understøtter eller holder magnetlåsen og ankerpladen med tilbehør, er robust og modstår slitage over tid.
- Vælg konsoller på baggrund af såvel funktion som den dørramme, magnetlåsen og ankerpladen skal monteres på.
- Bestem, hvordan kablerne kan trækkes på en sikker måde, for at beskytte mod hærværk og vejrlig (fx gennem fleksible karmoverføringer, kabelrender eller plastrør).

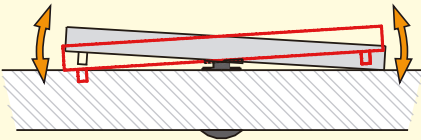

Ankerplade

- Det er vigtigt at fastgøre den elektromagnetiske lås og ankerplade solidt på deres understøtninger.
- Sørg for, at magneten og ankeret mødes jævnt over hele deres kontaktflader.
- Ankerpladen skal kunne svinge let omkring sin midterste monterings skrue for at kompensere for en eventuel ujævn placering af døren.

Sikkerhedswirer

Magnetlåsens beslag udsættes i deres levetid for gentagne stød og vibrationer. Åbningsfrekvens, lukninger, forsøg på at åbne en låst dør, og forsøg på hærværk kan medføre slitage, og at skruer og bolte løsnes. For at forhindre, at elektromagneten falder ned, skal de to medfølgende sikkerhedswirer monteres. Dette af hensyn til brugernes sikkerhed (se tegning).

Sikkerhedswirer

De to ender monteres på henholdsvis magnetlåsen og dørrammen

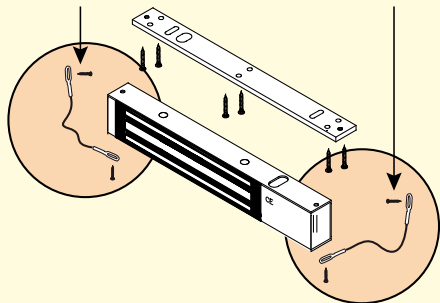

VEDLIGEHOOLD

















Elektromagneten er specialbehandlet for at modstå korrosion og slitage og kræver ikke megen vedligeholdelse. For maksimal effekt skal kontaktfladerne på elektromagneten og ankerpladen rengøres regelmæssigt med en klud og et mildt rengøringsmiddel. Hvis der forekommer spor af rust, anbefaler vi, at kontaktfladerne rengøres og olieres. Kontroller og spænd regelmæssigt alle monteringskrue på elektromagneten. Kontroller også, at ankerpladen kan vrikkes rundt om monteringskruen. Vi anbefaler gevindlås til alle fastgørelsesbolte.

3] MONTERINGSKIT





MAGNETLÅS V1SR

| | | | | | | | | | | |
|--|---|---|---|---|---|---|---|---|---|--|
|  |  |  |  |  |  |  |  |  |  |  |
| Elektro-magnet | Anker-plade | Monterings-beslag | Styretap 5x16 | Stålskive | Skrue M5x20 | Træskruer 3x25 | Nøgle 3 mm | Afstands-muffe | Monterings-bolt | Brugs-anvisning |
| 1 | 1 | 1 | 2 | 2 | 5 | 1 | 1 | 1 | 1 | 1 |

MAGNETLÅSENE V3S, V4S OG V5S

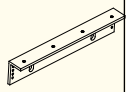
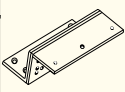
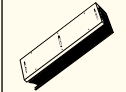
| | | | | | | | |
|--|---|---|---|---|---|---|--|
|  |  |  |  |  |  |  |  |
| Elektro-magnet | Anker-plade | Monterings-beslag | Styretap 5x16 | Stålskive | Træskruer 4x25 | Nøgle 3 mm | Nøgle 5 mm |
| 1 | 1 | 1 | 2 | 2 | 7 | 1 | 1 |
|  |  |  |  |  |  |  |  |
| Skrue M8x35 | Skrue M8x25 | Selvskærende skrue 3x8 | Afstands-muffe | Monterings-bolt | Sikkerheds-wire | Gummi-skive | Brugs-anvisning |
| 1 | 1 | 1 | 1 | 1 | 2 | 1 | 1 |

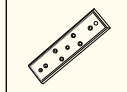
4] TILBEHØR

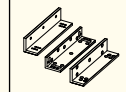
| | | | | | | | |
|--------------------|---|---|---|---|---|---|--|
| |  |  |  |  |  |  |  |
| Produkt | L3L4L5 | Z3Z4Z5 | UBKU | UBKP | AMA3AMA5 | DPM300 DPM500 | LZ1 |
| Beskrivelse | "L"-formet vinkelbeslag | "Z"-formet vinkelbeslag | Monteringsplade (ankerplade) - glasdør | Monteringsplade (elektromagnet) - glasdør | Monteringsplade (ankerplade) | Dørpositions-indikering | Monterings sæt: vinkelbeslag L & Z til V1SR (180 kg.) |

5] TILSLUTNINGER

| TERMINAL-BLOK | TILSLUTNING | V3S V4S - V5S | V3SR - V3SRB - V4SR V4SRB - V5SR - V5SRB |
|---------------|----------------------|------------------|---|
| + | 12 or 24V dc | ■ | ■ |
| - | - 0 V | ■ | ■ |
| N.C | NC (Normally closed) | - | ■ |
| COM | COM | - | ■ |
| N.O | NO (Normally open) | - | ■ |



**Fabriks-
indstilling:
12 V**

NO / NC-signalet skifter kun, når magnetlåsen er låst, ikke når døren er lukket.

MED INDBYGGET PCB-KORT

V1SR

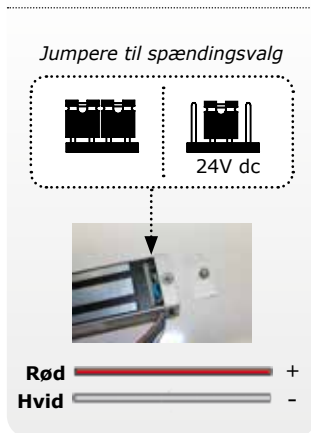

V3S__ - V4S__ - V5S__

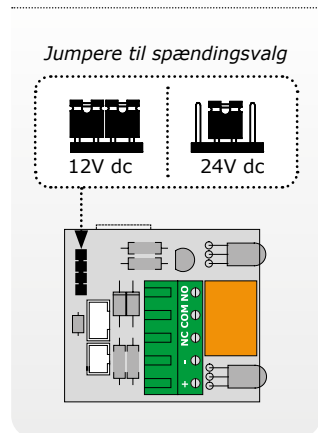

TILSLUTNING UDEN PCB-KORT

12V DC

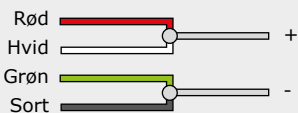

24V DC

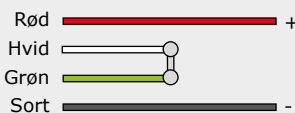

KONTAKT



VIGTIGT

Kontroller, at jumperen sidder rigtigt, før du tilslutter strømmen. En forkert placeret jumper kan beskadige elektromagneten. Denne type skade dækkes ikke af garantien.

6] MONTERING (EKSEMPEL: V3S-SERIEN)

Montering på udadåbnende dør

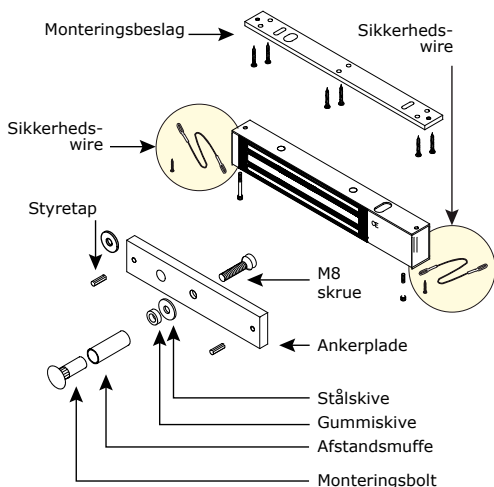

UDEFRA

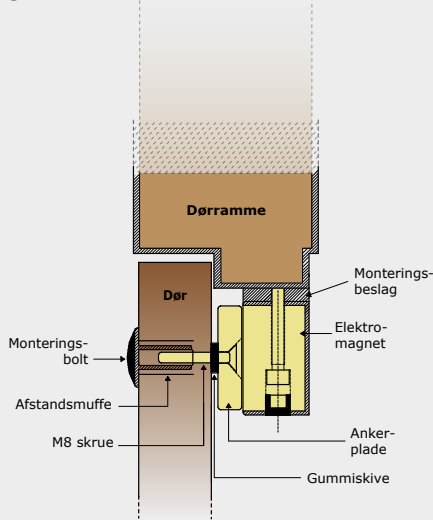

Udadåbnende dør.

Montering på indadgående dør

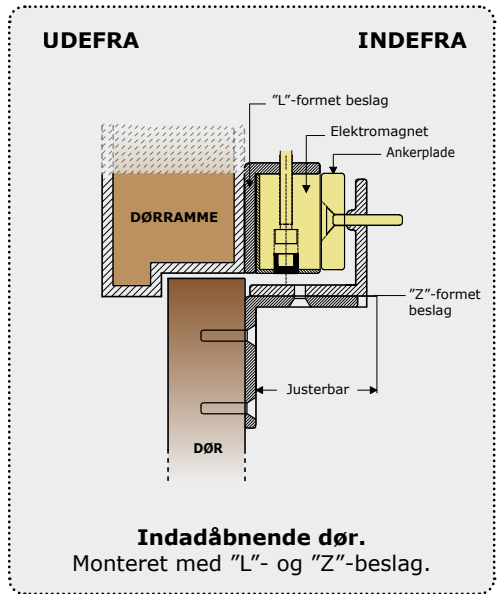
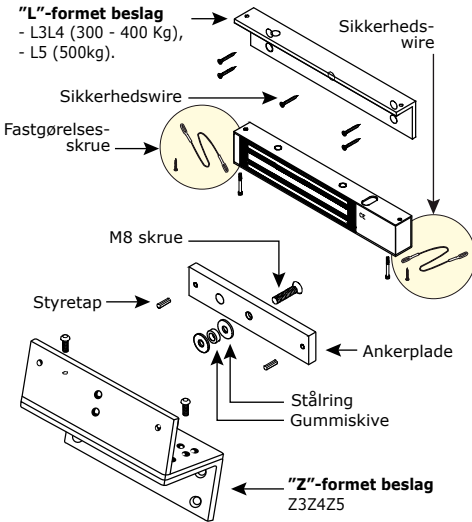

7] MONTERING MED TILBEHØR

Montering med ankerhus

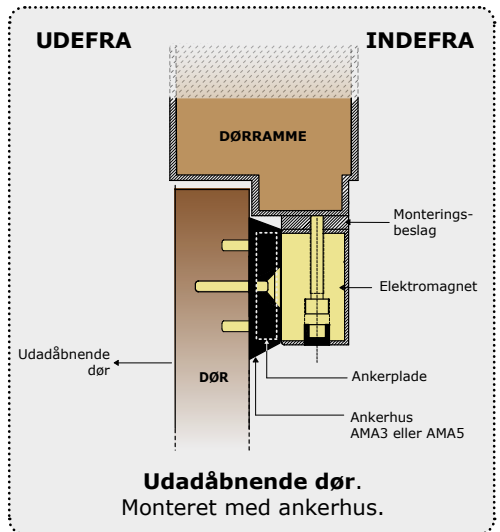
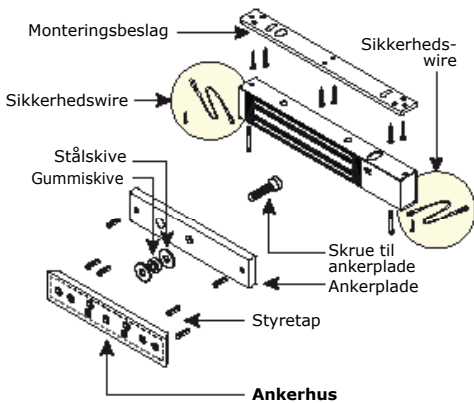

Installation med beslag til glasdør

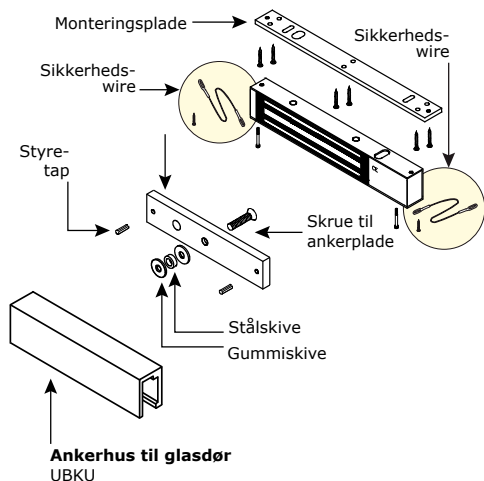

UDEFRA

INDEFRA

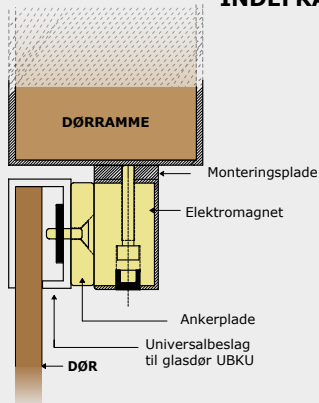

Udadåbende dør.

Installeret med UBKU-beslag.

Installation med beslag til glasdør

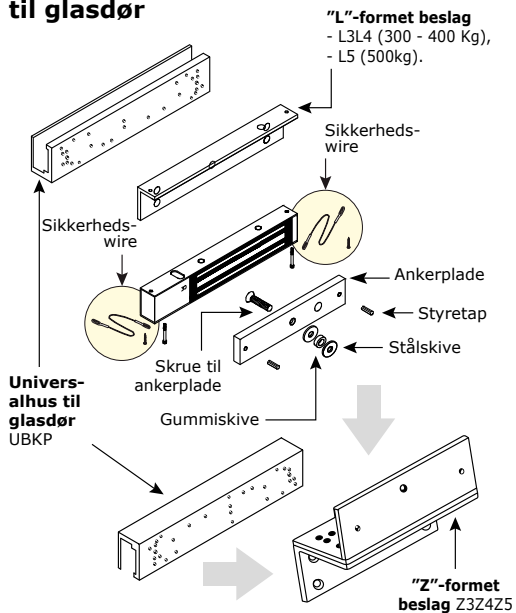

UDEFRA

INDEFRA

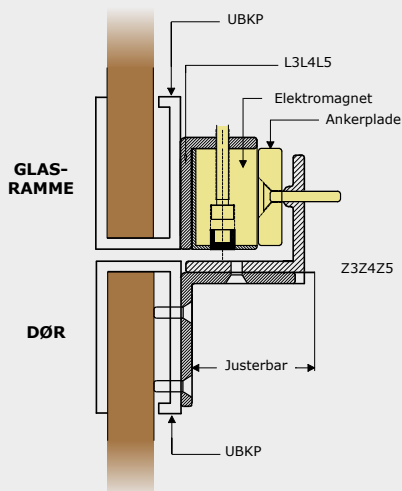

Indadåbende dør.

Installeret med UBKP, L3L4L5 og Z3Z4Z5-beslag.

Installation med DPM300 - DPM400 - DPM500 (Dørpositionsovervågning)*

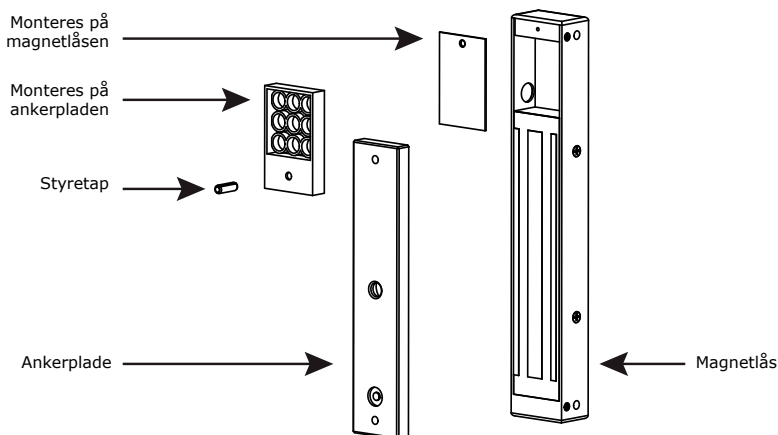

8] FEJLSØGNING

| PROBLEM | MULIG ÅRSAG | LØSNING |
|-------------------------------|---|---|
| Døren kan ikke låses | Elektromagneten modtager ikke jævnstrøm (DC). | <ul style="list-style-type: none"> - Kontroller, at kablerne er forbundet til de rigtige terminaler. - Kontroller, at strømforsyningen er korrekt dimensioneret. - Kontroller, at elektromagneten får den rigtige spænding. |
| Holdekraften er nedsat | Elektromagneten og ankerpladen er ikke helt parallelle. | <ul style="list-style-type: none"> - Kontroller, at elektromagneten modtager den rigtige spænding. - Kontroller, at elektromagneten og ankerpladen er parallelle og mødes ordentligt. - Kontroller, at kontaktfladerne er rene og fri for rust. - Kontroller, at ankerpladen kan vrikkes rundt om skruen. |
| | Lav spænding eller ankerpladen er blokeret. | <ul style="list-style-type: none"> - Kontroller, at elektromagneten modtager den rigtige spænding. - Kontroller, at ankerpladen er fæstnet korrekt, og at alle gummidele er bløde. |
| Fejlsignal | For lav spænding eller kontaktfladerne mødes ikke helt. | <ul style="list-style-type: none"> - Kontroller strømforsyningen. - Kontroller dimensionerne på kablerne mellem strømforsyning og elektromagnet. - Ex: $2 \times 1.5\text{mm}^2 \geq 10\text{m}$. |

* Valgfrit. Sælges separat.



Extranet : CDVI_IM V_S CMYK A5 EN-SE-DK 01

CDVI Group

FRANCE (Headquarters)

Phone: +33 (0) 1 48 91 01 02

.....

CDVI FRANCE + EXPORT

+33 (0) 1 48 91 01 02

www.cdvi.com

CDVI AMERICAS [CANADA - USA]

+1 (450) 682 7945

www.cdvi.ca

CDVI BENELUX [BELGIUM - NETHERLANDS - LUXEMBOURG]

+32 (0) 56 73 93 00

www.cdviBenelux.com

CDVI TAIWAN

+886 (0) 42471 2188

www.cdviChina.cn

CDVI SUISSE

+41 (0) 21 882 18 41

www.cdvi.ch

CDVI CHINA

+86 (0) 10 84606132/82

www.cdviChina.cn

CDVI IBÉRICA [SPAIN - PORTUGAL]

+34 (0) 935 390 966

www.cdviIberica.com

CDVI ITALIA

+39 (0) 321 90 573 - www.cdvi.it

CDVI MAROC

+212 (0) 5 22 48 09 40

www.cdvi.ma

CDVI NORDICS [SWEDEN - DENMARK - NORWAY - FINLAND]

+46 (0) 31 760 19 30

www.cdvi.se

CDVI UK [UNITED KINGDOM - IRELAND]

+44 (0) 1628 531300

www.cdvi.co.uk

CDVI POLSKA

+48 (0) 12 659 23 44

www.cdvi.com.pl

All the information contained within this document (pictures, drawings, features, specifications and dimensions) could be perceptibly different and can be changed without prior notice.

www.cdvigroup.com