



Addressable fire alarm sounder

SPP-400

Firmware version 1.00

EN

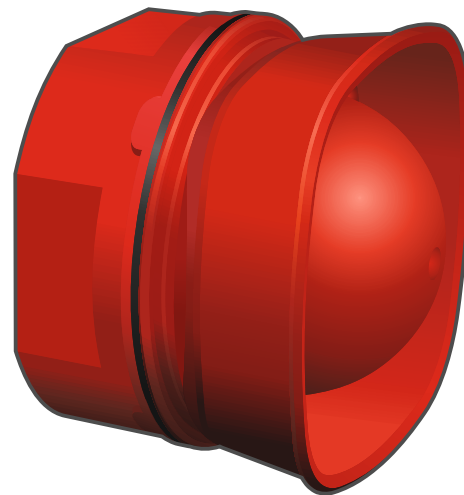

spp-400_en 02/23

Satel®

SATEL sp. z o.o. • ul. Budowlanych 66 • 80-298 Gdańsk • POLAND
tel. +48 58 320 94 00
www.satel.pl

IMPORTANT

The device should be installed by qualified personnel.

Prior to installation, please read carefully this manual in order to avoid mistakes that can lead to malfunction or even damage to the equipment.

Disconnect power before making any electrical connections.

Changes, modifications or repairs not authorized by the manufacturer shall void your rights under the warranty.

The following symbols may be used in this manual:



- note,



- caution.

The SPP-400 indoor sounder is used for acoustic alarm signaling. It is designed to operate in the detection line of the ACSP-402 addressable fire alarm control panel.

1. Features

- Acoustic signaling by means of piezoelectric transducer.
- Signaling controlled by the control panel:
 - different tones for different alarm conditions.
 - 32 selectable tones.
- Double-sided short-circuit isolator.
- Power supply from the detection line.

2. Installation



Disconnect power before making any electrical connections.

The sounder is designed for installation indoors, in spaces with normal air humidity.

1. Turn the cover counter-clockwise and remove it (Fig. 1).

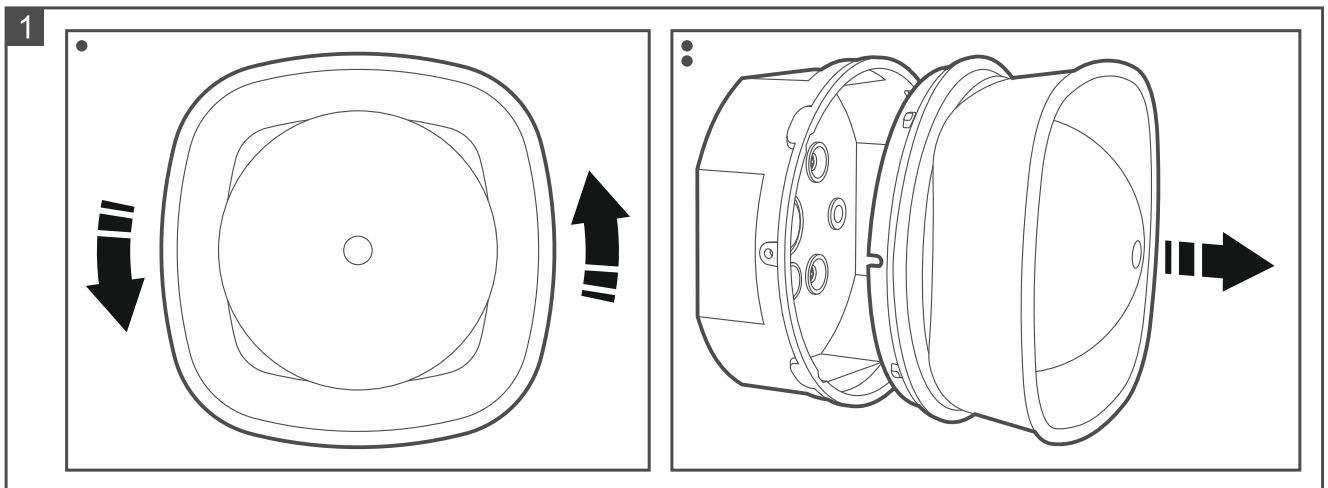

2. Drill the holes for screws in the enclosure base. Use the countersunk screws (Fig. 2) or the non-countersunk screws (Fig. 3) to fasten the enclosure base to the wall.
3. Drill the hole for cables in the enclosure base (Fig. 4).
4. Place the enclosure base against the wall and mark the location of mounting holes.
5. Drill the holes for wall plugs (screw anchors) in the wall.
6. Run the cables inside the enclosure base.
7. Use wall plugs and screws to secure the enclosure base to the wall. Select wall plugs specifically intended for the mounting surface (different for concrete or brick wall, different for plaster wall, etc.).

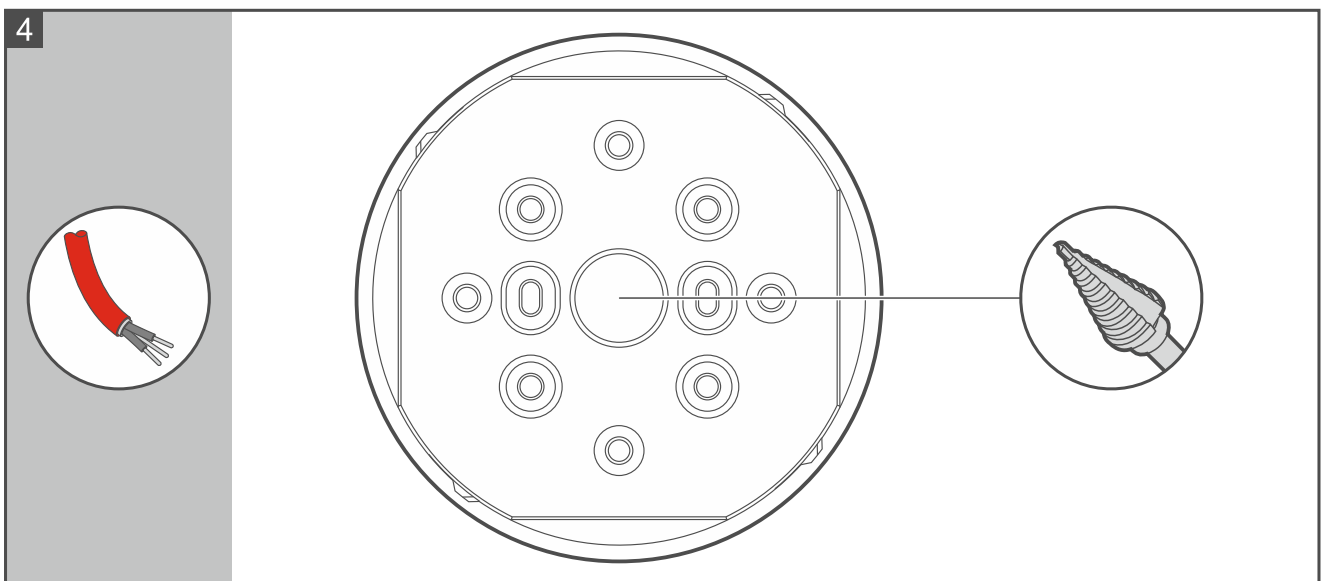
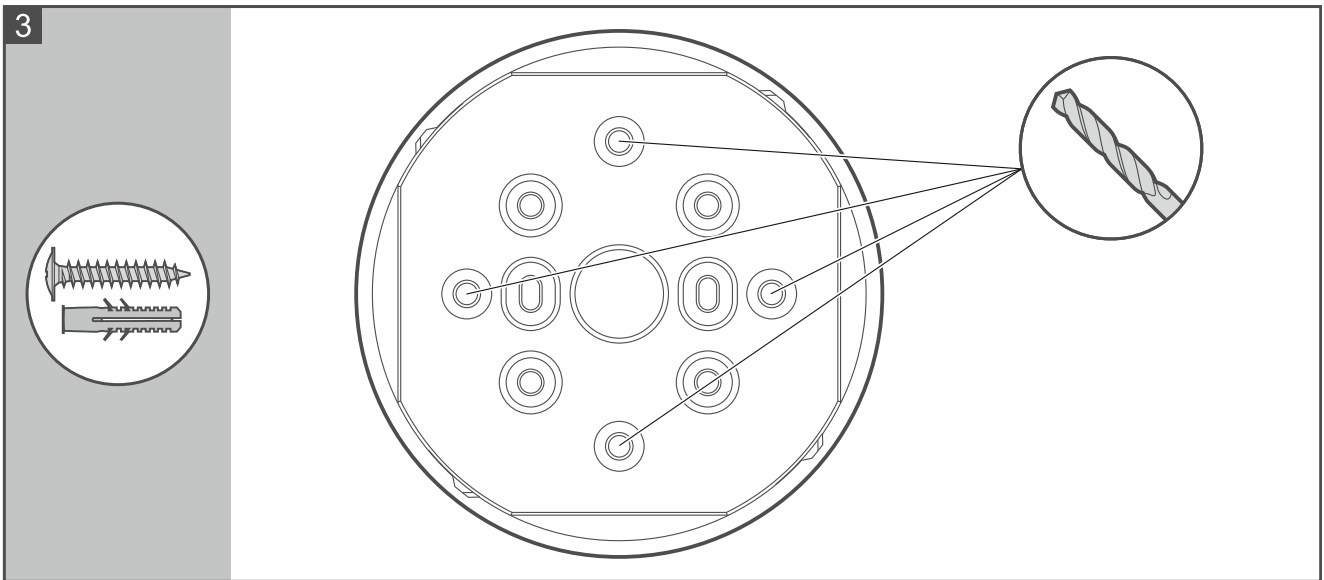
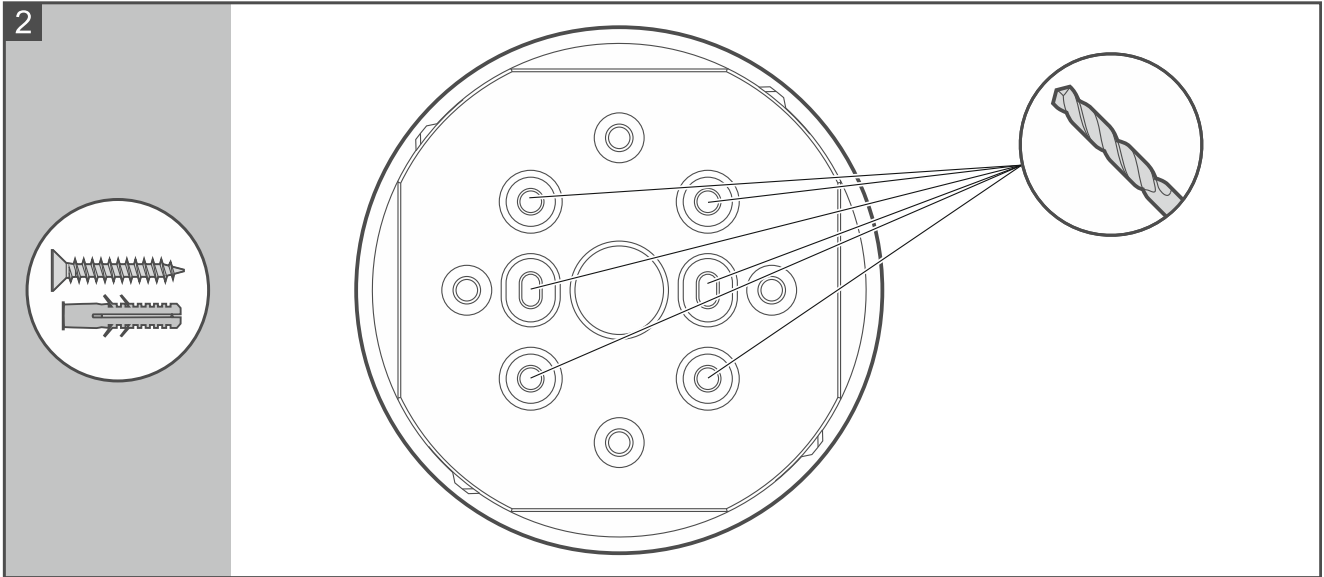

8. Connect the detection line wires to the sounder (Fig. 5 – loop; Fig. 6 – radial circuit). To terminals A+ and A-, connect the wires from the control panel / previous device. Connect the wires to terminals B+ and B- to connect the sounder to the next device / control panel. For radial circuits, if the sounder is the last device in the circuit, do not

connect the wires to terminals B+ and B- (Fig. 6). Connect the cable shields to the E / \perp terminals.

9. Replace the cover and turn it clockwise (Fig. 7).

10. Lock the cover with a screw (Fig. 8).

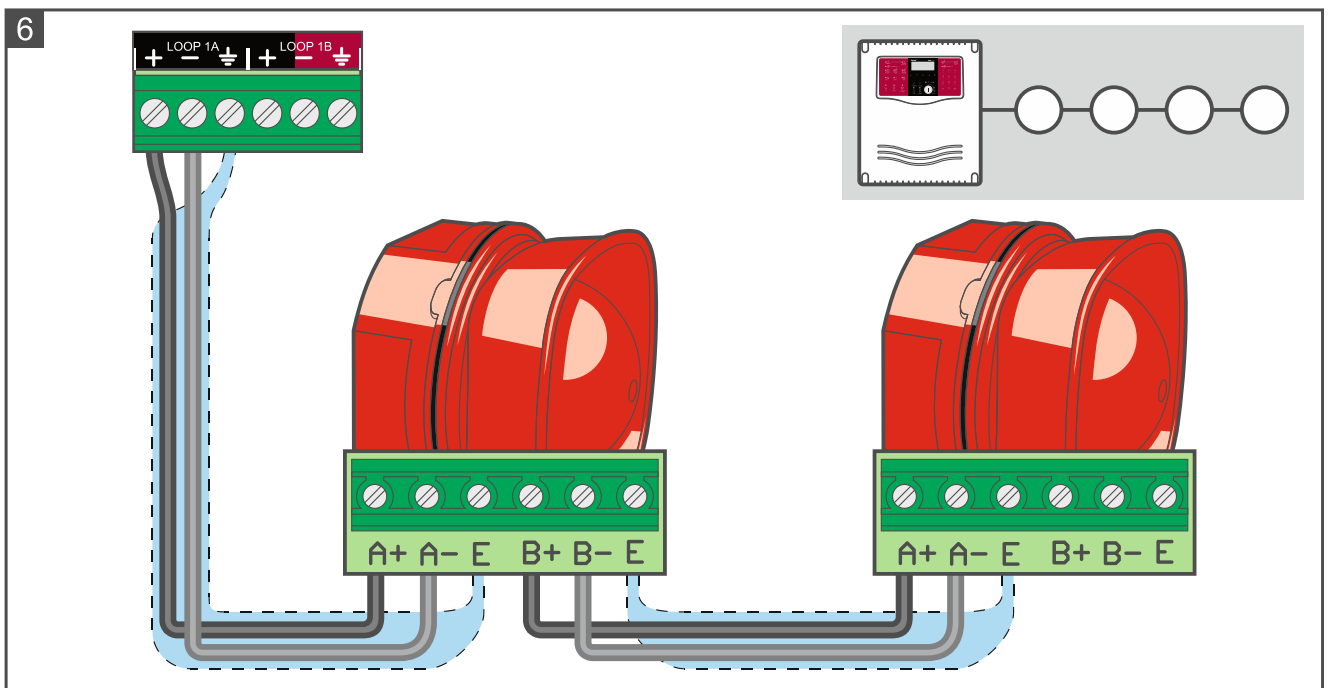
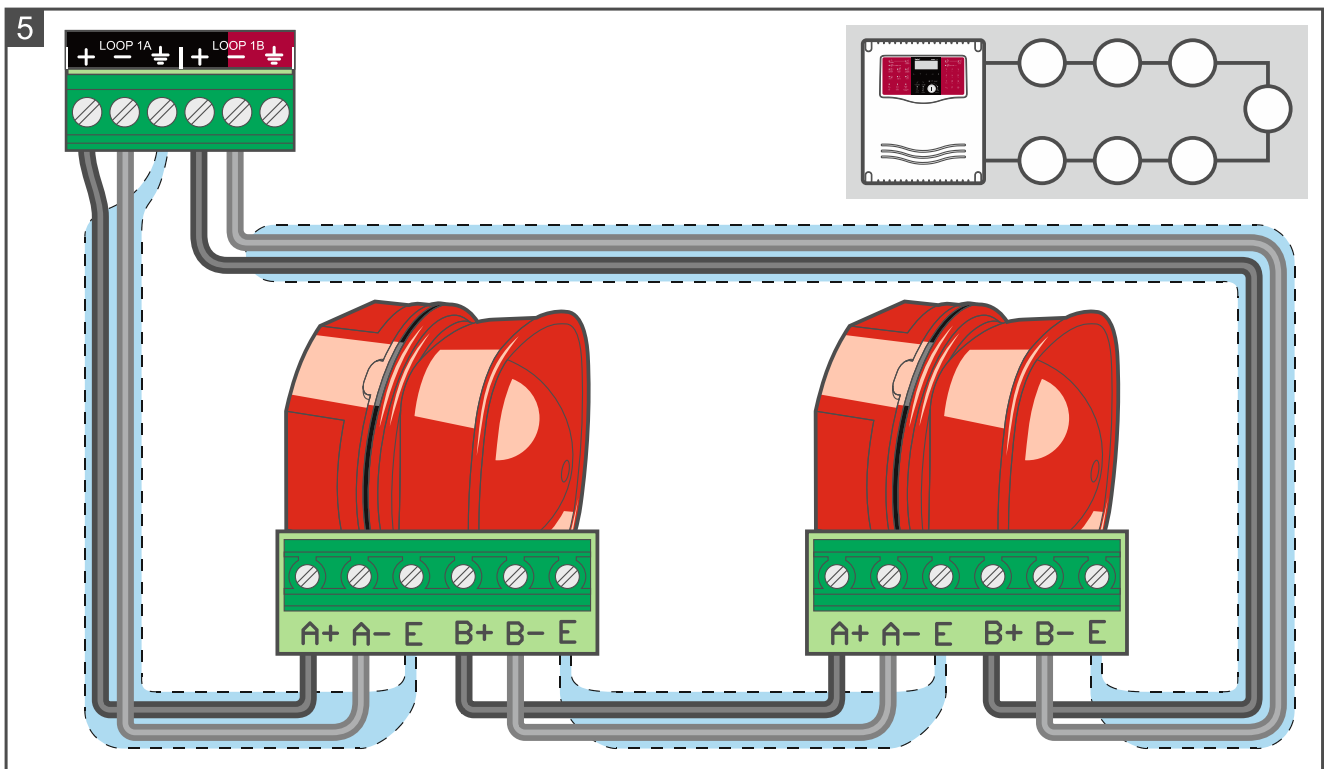

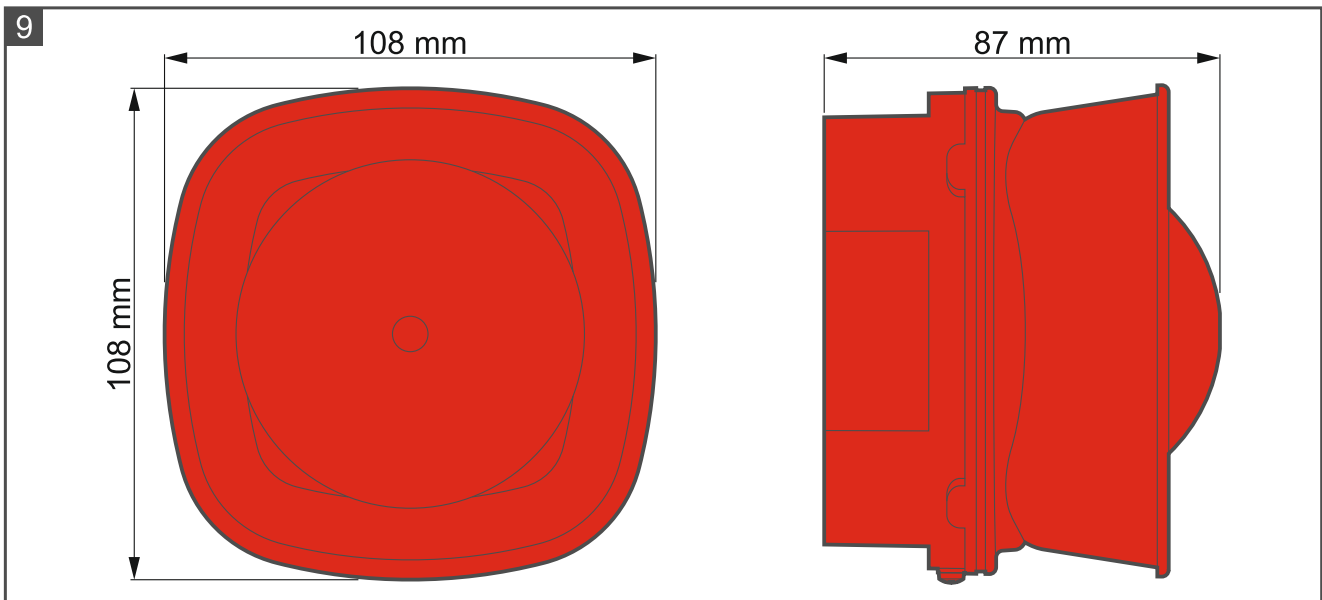
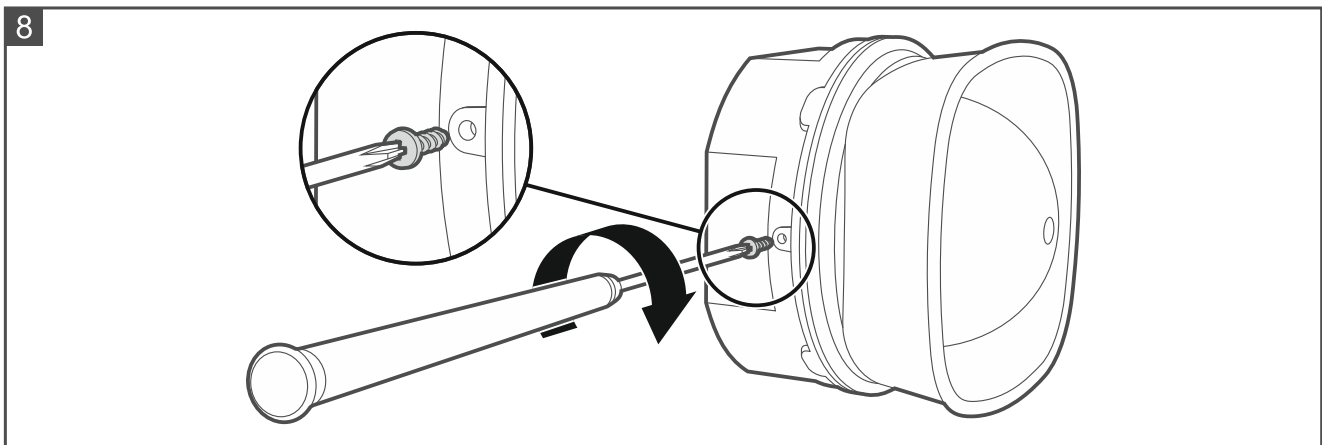
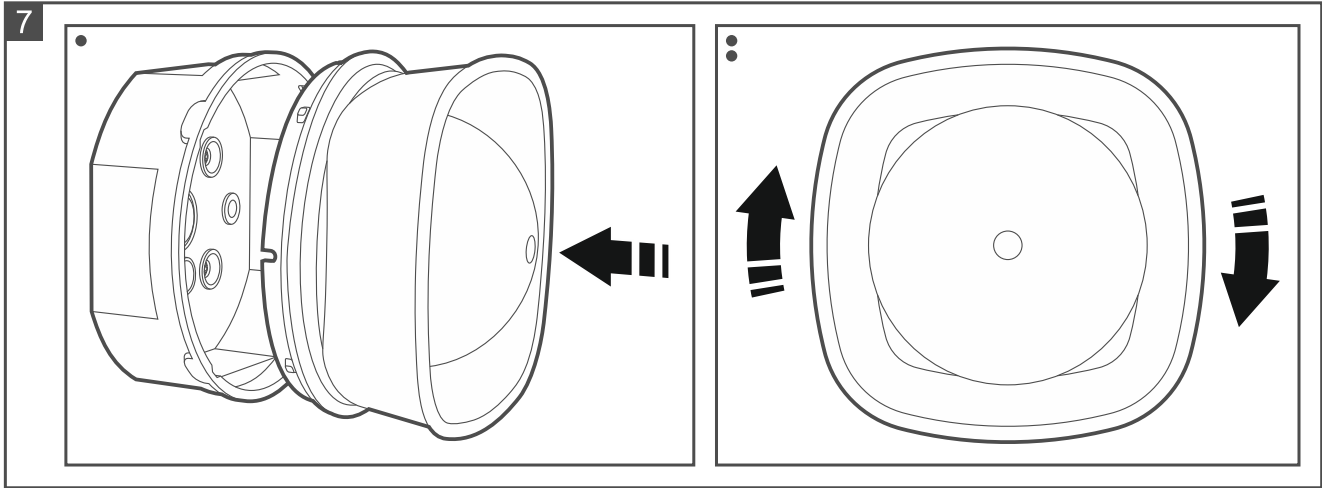

3. Acoustic signaling

Configure the acoustic signaling settings in the control panel. For each alarm condition you can select one of the 32 available tones (see: Table 1).













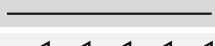















No	Acoustic signaling		
		Frequency Hz	Description
1		800 & 970	2 Hz (250 ms – 250 ms)
2		800-970	7 Hz (7/s)
3		800-970	1 Hz (1/s)
4		2850	Continuous
5		2400-2850	7 Hz
6		2400-2850	1 Hz
7		500-1200	3 s sound, 0.5 s silence, repeated
8		1200-500	1 Hz
9		2400-2850	2 Hz (250 ms – 250 ms)
10		970	0.5 Hz (1 s)
11		800 & 970	1 Hz (500 ms – 500 ms)
12		2850	0.5 Hz (1 s)
13		970	0.8 Hz (250 ms / 1 s)
14		970	Continuous
15		554 & 440	100 ms – 400 ms
16		660	3.3 Hz (150 ms)
17		660	0.28 Hz (1.8 s)
18		660	0.05 Hz (13 s / 6.5 Hz)
19		660	Continuous
20		554 & 440	0.5 Hz (1 s)
21		660	1 Hz (500 ms – 500 ms)
22		2850	4 Hz (150 ms – 100 ms)
23		800-970	50 Hz
24		2400-2850	50 Hz
25		970	3 x 500 ms sound, 1.5 s silence, repeated
26		800-970	3 x 500 ms sound, 1.5 s silence, repeated
27		970 & 800	3 x 500 ms sound, 1.5 s silence, repeated
28		2400	Continuous
29		990 & 650	2 Hz (250 ms – 250 ms) (Symphoni Tones)
30		510 & 610	2 Hz (250 ms – 250 ms) (Squashni Micro Tones)
31		300-1200	1 Hz
32		510 & 610	1 Hz (500 ms – 500 ms)

Table 1.

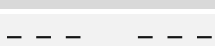
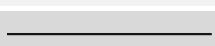
Tone / supply voltage	Angle-dependent [°] minimum sound level [dBA]					
	15°	45°	75°	105°	135°	165°
1 / 18 VDC	81.1	87.2	91.5	91.9	87.1	80.7
1 / 26 VDC	82.9	88.9	94.4	94.6	91.5	84.1
2 / 18 VDC	79.3	86.9	90.5	90.2	85.4	78.4
2 / 26 VDC	82.1	88.8	92.9	93.0	89.3	81.1
3 / 18 VDC	80.2	88.0	91.7	91.8	86.3	79.5
3 / 26 VDC	82.5	89.3	93.9	94.1	89.9	81.6
4 / 18 VDC	71.8	82.7	85.0	84.1	82.1	72.1
4 / 26 VDC	71.0	81.5	83.6	85.3	83.1	71.6
5 / 18 VDC	76.1	85.3	86.6	86.0	83.2	74.6

Tone / supply voltage	Angle-dependent [°] minimum sound level [dBA]					
	15°	45°	75°	105°	135°	165°
5 / 26 VDC	76.2	84.6	86.5	87.1	84.9	76.0
6 / 18 VDC	78.0	86.7	88.0	86.8	85.1	75.8
6 / 26 VDC	77.5	85.5	86.7	87.4	85.4	77.0
7 / 18 VDC	80.1	87.5	91.7	91.8	86.1	80.4
7 / 26 VDC	83.8	88.9	94.5	94.8	90.8	83.3
8 / 18 VDC	79.7	87.0	90.9	90.9	85.4	79.1
8 / 26 VDC	82.4	88.5	93.4	93.6	89.5	82.3
9 / 18 VDC	75.9	81.6	86.9	86.2	80.6	74.7
9 / 26 VDC	76.0	81.6	86.1	87.3	83.0	76.2
10 / 18 VDC	79.9	87.2	91.6	91.8	87.5	81.1
10 / 26 VDC	83.9	88.7	94.5	94.4	91.4	83.6
11 / 18 VDC	79.8	87.3	91.9	92.1	87.5	80.4
11 / 26 VDC	82.9	88.5	93.8	94.1	90.7	83.3
12 / 18 VDC	71.4	83.9	86.7	85.8	83.5	72.7
12 / 26 VDC	75.8	86.2	88.6	89.6	87.9	76.1
13 / 18 VDC	79.3	86.9	91.5	91.7	87.1	80.1
13 / 26 VDC	83.3	88.7	94.1	94.8	91.0	83.6
14 / 18 VDC	79.4	86.9	91.4	91.6	87.3	80.8
14 / 26 VDC	81.7	88.1	93.2	93.4	90.3	82.5
15 / 18 VDC	77.2	84.2	87.2	87.1	82.3	77.1
15 / 26 VDC	78.3	84.8	88.6	88.7	84.9	78.6
16 / 18 VDC	76.6	85.6	87.9	87.7	84.0	75.2
16 / 26 VDC	81.0	86.6	91.1	91.5	87.7	80.8
17 / 18 VDC	78.0	86.9	89.3	89.3	84.8	78.0
17 / 26 VDC	82.2	87.9	92.5	92.7	88.8	82.1
18 / 18 VDC	77.9	86.8	89.1	88.9	85.1	77.3
18 / 26 VDC	88.2	87.7	92.2	92.6	88.8	81.9
19 / 18 VDC	78.0	87.0	89.3	89.2	84.8	77.2
19 / 26 VDC	82.3	87.9	92.4	92.8	88.8	82.1
20 / 18 VDC	77.0	84.0	87.6	87.4	82.7	77.5
20 / 26 VDC	78.3	84.6	88.3	88.7	84.9	78.4
21 / 18 VDC	77.8	87.1	89.2	89.1	84.7	77.0
21 / 26 VDC	82.2	88.0	92.5	92.7	88.9	82.1
22 / 18 VDC	72.5	84.6	87.7	86.6	84.4	73.7
22 / 26 VDC	74.9	85.4	87.5	88.3	86.7	75.1
23 / 18 VDC	79.1	86.5	89.8	89.6	84.6	78.1
23 / 26 VDC	81.8	88.4	92.5	92.6	89.1	81.1
24 / 18 VDC	75.7	84.0	86.5	85.6	82.8	74.1
24 / 26 VDC	75.9	84.3	86.1	86.6	84.3	75.7
25 / 18 VDC	79.9	87.4	92.0	92.1	87.5	80.9
25 / 26 VDC	82.7	88.8	94.2	94.9	91.8	84.3
26 / 18 VDC	80.0	86.9	91.1	90.8	85.5	78.6
26 / 26 VDC	82.8	88.6	94.0	93.9	89.6	81.6
27 / 18 VDC	79.4	86.9	91.5	91.7	87.1	80.1
27 / 26 VDC	82.4	88.5	94.0	94.8	91.6	84.1

Tone / supply voltage	Angle-dependent [°] minimum sound level [dBA]					
	15°	45°	75°	105°	135°	165°
28 / 18 VDC	75.7	79.5	86.9	86.0	78.8	74.6
28 / 26 VDC	76.4	80.3	85.9	87.1	80.5	76.4
29 / 18 VDC	78.9	87.5	90.9	90.8	85.4	79.5
29 / 26 VDC	84.0	88.4	94.1	94.5	90.2	84.1
30 / 18 VDC	77.2	85.5	89.0	88.9	83.6	77.1
30 / 26 VDC	80.7	88.4	92.3	92.0	87.9	79.9
31 / 18 VDC	78.9	86.4	90.1	90.2	84.9	78.8
31 / 26 VDC	79.8	86.5	91.7	91.8	87.9	80.5
32 / 18 VDC	77.1	85.5	89.0	89.0	83.7	77.3
32 / 26 VDC	80.7	88.3	92.2	91.9	87.8	79.8

Table 2.

4. Maintenance

The fire alarm system elements require regular maintenance. The periodic checks of the SPP-400 sounder should be carried out at least every 6 months. In spaces where working conditions are difficult (e.g. dust, aggressive environment that may cause corrosion, etc.), the periodic checks should be carried out more often.

As part of maintenance, start a test in the control panel and make sure the acoustic signaling is working. Please go to the ACSP-402 control panel manuals to find out how to start the test. Start of the test and test activation of devices will be registered in the control panel event log. During the test, make sure the device is in its right place (e.g. it has not been swapped with another device).

5. Specifications

Supply voltage	18...26 VDC
Quiescent current consumption	0.25 mA
Alarm current consumption	4 mA
Operating temperature range.....	-10°C...+55°C
Maximum humidity	95%
Protection rating.....	IP21C
Operating environment type.....	A
Dimensions	108 x 108 x 87 mm
Weight.....	224 g

The SPP-400 fire alarm sounder conforms to the essential requirements of the EU Regulations and Directives:

CPR 305/2011 Regulation of the European Parliament and of the Council of 9 March 2011 laying down harmonized conditions for the marketing of construction products and repealing the Council Directive 89/106/EEC on construction products;

EMC 2014/30/UE Electromagnetic Compatibility Directive;

LVD 2014/35/EU Low Voltage Directive.

The CNBOP-PIB Certification Body in Józefów issued the Certificate of Constancy of Performance **1438-CPR-0859** for the construction product SPP-400 fire alarm sounder, confirming its compliance with the requirements of EN 54-3:2003+A1:2002+A2:2006 and EN 54-17:2005 + AC:2007.

The Certificate and the Declaration of Performance can be downloaded from the www.satel.pl website.

The SPP-400 fire alarm sounder has been granted the Certificate of Admittance **No 4768/2022** by the CNBOP-PIB in Józefów.

The Certificate of Admittance can be downloaded from the www.satel.pl website.



SATEL Sp. z o.o. • ul. Budowlanych 66 • 80-298 Gdańsk • POLAND

1438

1438-CPR-0859

Declaration of Performance DOP/CPR/0859

EN 54 3:2003+A1:2002+A2:2006

EN 54-17:2005 + AC:2007

Fire safety.

SPP-400 fire alarm sounder (type A).

Use – see the Declaration of Performance DOP/CPR/0859.

Technical specifications – see this manual.