



testifire[®]

MULTI-STIMULUS DETECTOR TESTER

Quick Start Guide



Multi-Detector Test
Apparatus Used to Verify
a Detector's Functional
Operation

Preparation For Use

1. Charging the Battery Baton



- The charger can be connected to a mains power outlet or a 12 volt vehicle socket (1). When connected, the red Power LED will illuminate.
 - Connect the Battery Baton to the charger and turn the locking ring (2 & 3).
 - The yellow Fast Charge LED will illuminate (4).
 - Charge times vary but can be 75-90 minutes when charging a fully discharged Battery Baton.
 - When fully charged, the charger will switch to Trickle Charge and the green LED will illuminate (4).
- Note:** Use only NiMH Battery Batons with Testifire.

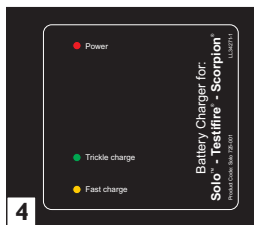

2. Inserting the Battery Baton

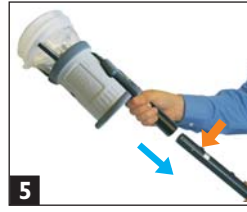

- To insert the Battery Baton, hold the Testifire head unit by the handle and depress the upper spring button on the Battery Baton. Align the button with the location hole in the handle and push the Battery Baton into the handle until the button springs up through the location hole (5).



- Insert the other end of the Battery Baton into the Solo access pole and depress the lower spring button. Align it with the location hole and push the Battery Baton further into the pole until the button springs up through the hole (6).

3. Removal & Replacement of Smoke Capsules (Testifire 1000 & 2000 series)

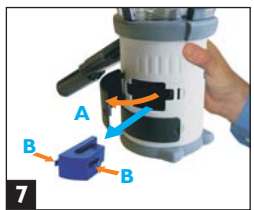

- Removal:**
- Release the upper access cover **A** (7) on the body of the Testifire by opening it from the right hand side.
- Note:** Testifire 1000 series units only have one access cover.
- Squeeze the two clips **B** of the used capsule and gently pull the capsule out.

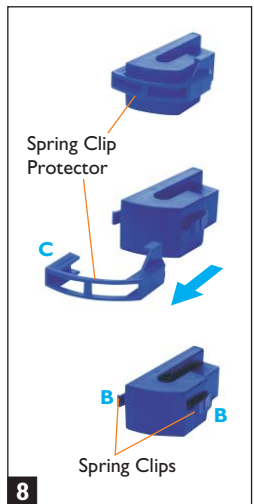

- Replacement:**
- Remove the capsule from its outer carton and Anti-Static bag.
 - Remove the spring clip protector cap from the new capsule **C** (8).
 - Holding the capsule by the spring clips with the label on the underside, carefully insert the new capsule into the capsule port. Push it into position, ensuring that the clips spring out positively on both sides of the capsule.
 - Close the access cover **A** securely.

4. Removal & Replacement of CO Capsules (Testifire 2000 series only)



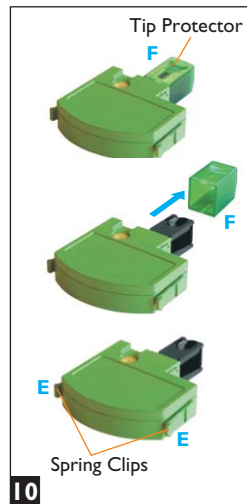

- Removal:**
- Only replace the CO capsule when it is empty. Turn Testifire off for five minutes to allow the capsule to cool down before removing it.
 - Release the lower access cover **D** (9) by opening it from the right hand side.
 - Squeeze the spring clips **E** on each side and gently pull the capsule out.
 - Do not touch the tip of the CO capsule as it may be hot.



- Replacement:**
- Remove the capsule from its carton and Anti-Static bag.
 - Remove the tip protector **F** (10).
 - Hold the capsule by the spring clips with the label uppermost. Carefully insert into position, ensuring that the clips spring out positively on both sides.
 - Close the access cover **D** securely.

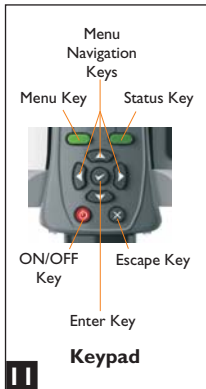

5. Using the Menus



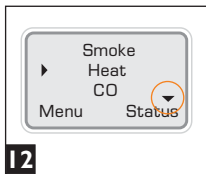

- Using the 'UP' and 'DOWN' menu navigation keys  (11), you can move the cursor through the 'MAIN' menu. Press the 'ENTER' key  to select stimuli from the 'MAIN' menu.

- Pressing the 'ESCAPE' key  goes back to the 'MAIN' menu, or when a test sequence has been programmed and the 'MAIN' menu is displayed, the 'ESCAPE' key will cancel the programmed test sequence.

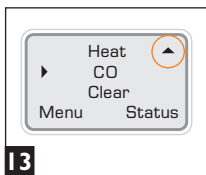

- A 'DOWN' arrow  on the bottom right of the 'MAIN' menu indicates more options are available below. Use the 'DOWN' key  on the keypad to move down through the menu. (12).



- The 'UP' arrow  on the 'MAIN' menu indicates more options available above. Use the 'UP' key  on the keypad to move up through the menu (13).

- Press the 'LEFT' key  on the keypad to go back one menu level.

7. Adjusting the Head Angle



- Correct head angle adjustment is important. The detector should touch the base of the inner clear cup (22).

- To adjust the head unit hold the body (18) and, pulling gently against the spring, angle the head unit away from the Battery Baton (19). The head unit will lock and remain in that position for testing.





6. Turning the Unit On



- To turn the unit on, press and hold the red 'ON-OFF key'  for 2 seconds (14). The 'Status' LED will flash slowly green to indicate that the unit is in 'STANDBY' mode.



- The first time the unit is powered-on you will be prompted to select the operating language for your region. Use the 'UP' and 'DOWN' keys  to navigate and use the 'ENTER' key  to select your language (15).

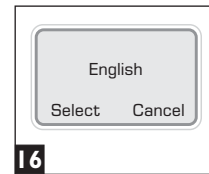

- This will display a confirmation screen (16). Press the 'MENU' key to confirm or the 'STATUS' key to cancel. The 'MAIN' menu will be displayed.

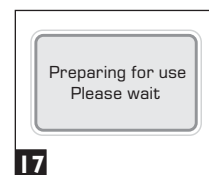

- After long periods of non-use or when a Smoke Capsule has been replaced, the unit will self-prime at power-on. The 'Preparing for use Please wait' message will be displayed for a short period (17).

8. Testing High Profile Detectors





- When testing high profile detectors, remove the inner clear cup. Place your finger in the cut-out and carefully lift out the inner cup (20). This will allow the detector to touch the platform (21).

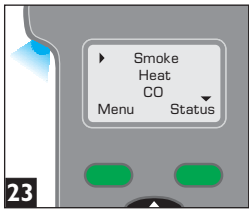

Testing a Detector

I. How to Perform a Test



- To carry out a simple, single stimuli test, use the 'UP' and 'DOWN' keys  on the keypad to highlight the stimulus required e.g. 'Smoke' (23).
- Raise the Testifire head unit up to the detector to be tested, and place it centrally over the detector.



- As the detector enters Testifire, the infrared beam is interrupted by the body of the detector and the chosen test will begin, indicated by the 'Status' LED flashing faster.

Note: It is very important that the detector under test is in the correct position (22). Ideally, the bellows should seal against the ceiling surface.

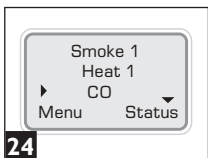
2. Simultaneous Testing (selected tests at the same time)



In this example, 'Smoke' and 'Heat' are selected as a simultaneous test (24).

- Move the cursor to 'Smoke' and press the 'ENTER' key  '1' will be displayed alongside 'Smoke'.
- Move the cursor to 'Heat' and press the 'ENTER' key  '2' will be displayed alongside 'Heat'. Press 'ENTER' once more to display '1' alongside 'Heat'.
- Repeat the above as required for additional stimuli.
- To delete a test setup, use the 'ESCAPE' key .

1. **Programme the tests:** Smoke 1
Heat 1

2. **Raise Testifire over the detector:** 'Smoke' and 'Heat' are tested at the same time as test '1'.



3. **Lower Testifire from the detector:** The test is completed and ready to test another detector in the same way.

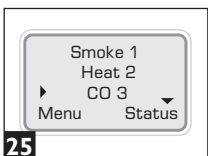

3. Sequential Testing (selected tests, one after another)



In this example, 'Smoke', 'Heat' and 'CO' are selected as a sequential test (25).

- Move the cursor to 'Smoke' and press the 'ENTER' key  '1' will be displayed alongside 'Smoke'.
- Move the cursor to 'Heat' and press the 'ENTER' key  '2' will be displayed alongside 'Heat'.
- Move the cursor to 'CO' and press the 'ENTER' key '3' will be displayed alongside 'CO'.
- To delete a test setup, use the 'ESCAPE' key .

1. **Programme the tests:** Smoke 1
Heat 2
CO 3

2. **Raise Testifire over the detector:** 'Smoke' is tested as test '1'.

3. **Lower for 2-10 seconds, then raise Testifire again:** 'Heat' is tested as test '2'.

4. **Lower for 2-10 seconds, then raise Testifire again:** 'CO' is tested as test '3'.

5. **Lower Testifire:** The test is completed and ready to test another detector in the same way.

4. Combined Simultaneous and Sequential Testing

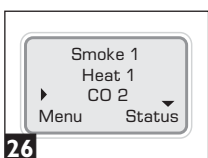

In this example, 'Smoke' and 'Heat' are combined as a simultaneous test followed by 'CO' (26).

- 'Heat' and 'Smoke' can be combined as the first operation, followed by a 'CO' test. **Note:** you will need to lower the head unit between each test.
- To delete a test setup, use the 'ESCAPE' key .

Using these methods, you can programme Testifire to combine tests and continue in sequence.

In this example 'Smoke' and 'Heat' are tested together as test '1' and then 'CO' is tested as test '2'.

Note: 'Clear' (clearing) can also be selected in any of the above operations.

Indicating LED Reference Chart

'Test Type' LED

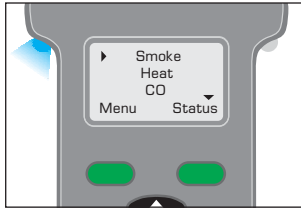

Blue Solid

Smoke Test in progress

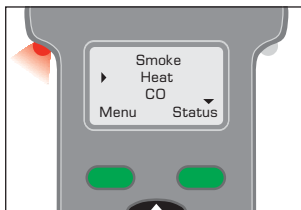

Red Solid

Heat Test in progress

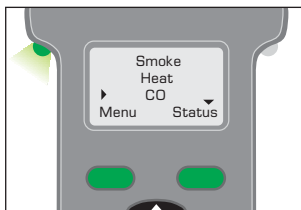

Green Solid

CO Test in progress

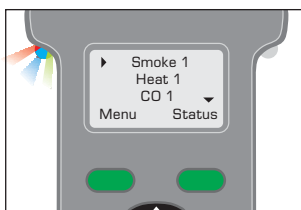

Red/Blue/Green Alternating

Smoke, Heat and CO test in progress at the same time (Simultaneous Testing)

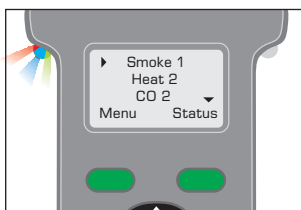

Blue Solid/ then Red/Green Alternating

'Test in progress' portion of Smoke, then Heat & CO combined testing (Sequential Testing)

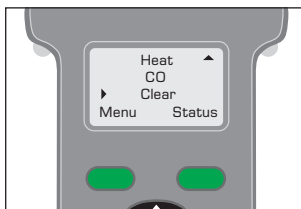

Not Illuminated

Clearing mode in operation

'Status' LED



Green Slow Flashing

'STANDBY' Mode



Green Fast Flashing

'OPERATIONAL' Mode (test in progress)



Red Flashing

(slow red flashing in 'STANDBY' mode or fast red flashing in operation)

Battery needs charging - Testifire still operational



Alternating Red/Green Flashing

'TIME OUT' Indication (after 2 minutes of continuous testing on one stimulus or combination of stimuli)



Red Solid

Error - see message on display (refer to *User Manual for a complete list of Indicating LED Error Messages*)



Green Solid

CO Cooling (Status LED 'blips' red or green. The next test will start when the capsule has cooled sufficiently)

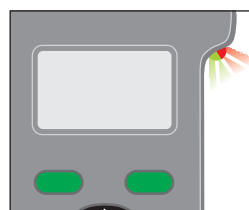

Alternating Red and Green fast flashes with long gaps

"CO Cooling phase" - Indication after a CO test has been carried out. Further CO test cannot be carried out until Status LED shows "STANDBY" mode.

Identification of Parts

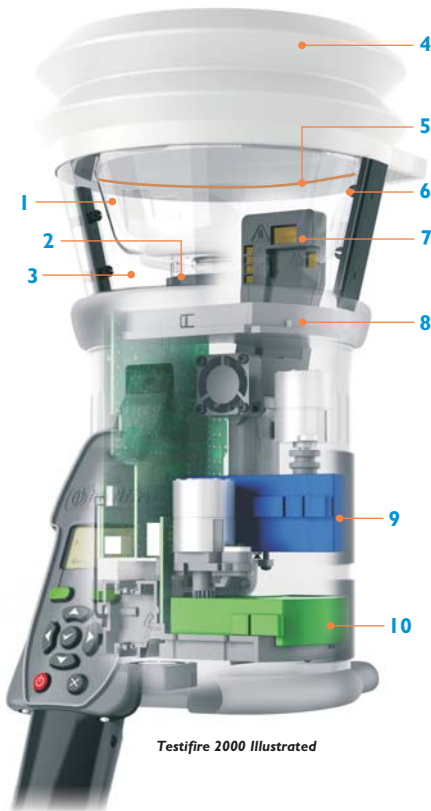

1. Inner Clear Cup
2. Platform
3. Clear Cup
4. Bellows
5. RFID Antenna*
6. Infrared Beam
7. Main Duct for Heat, Smoke and CO*
8. Testifire 100 RFID Bluetooth® Module**
9. Smoke Capsule TS3
10. CO Capsule TC3*
11. USB Port (on rear of unit)
12. User Interface Display (LCD)
13. 'Test Type' LED
14. 'Status' LED
15. Smoke Capsule Access Cover
16. CO Capsule Access Cover*
17. Adjustable Handle
18. Battery Baton
19. Infrared Remote Control Receivers

* Depending on model specification ** Future option

Replacement Capsules

- A Testifire Smoke Capsule TS3
- B Testifire CO Capsule TC3*

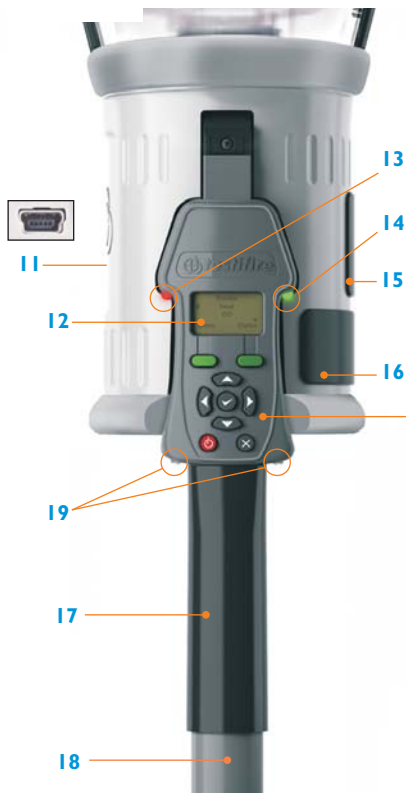
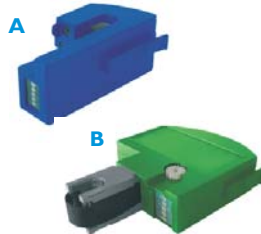

User Interface Keypad

- C Menu Key
- D Status Key
- E Menu Navigation Keys
- F Enter Key
- G ON/OFF Key
- H Escape Key

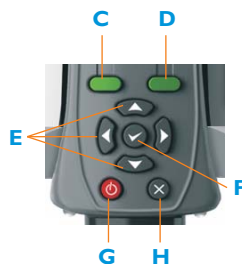

Infrared Remote Control

Generation of test stimuli starts when Testifire is positioned over a detector and remote controls are not generally required. Certain detectors (such as those with virtual chambers) have no physical features to cause stimuli generation to start. The optional infrared remote control can be used to initiate the test procedure in such situations.

General Safety Information



CAUTION Please refer to your User Manual and take clearnote of all warnings and cautions before using your Testifire.

Testifire has no user-serviceable parts. Do not disassemble. Refer to the manual for Service and Support information.



detector testers
testing technology from No Climb

No Climb Products Ltd
Edison House
163 Dixons Hill Road
Welham Green
Hertfordshire AL9 7JE
United Kingdom

Tel: +44 (0) 1707 282 760
Fax: +44 (0) 1707 282 777

info@detektortesters.com

As our policy is one of continuous improvement, details of products described within this publication are subject to change without notice. All information provided here is believed to be correct at the time of going to press. Every effort has been made to ensure the accuracy of information which is provided in good faith but nothing contained herein is intended to incorporate any representation or warranty, either express or implied or to form the basis of any legal relations between the parties hereto, additional to or in lieu of such as may be applicable to a contract of sale or purchase.

www.detektortesters.com

LI32157-3